

# BG-8K-1616MA

**16x16 8K UHD HDMI 2.1 Matrix Switcher with Auto  
Downscaling/Audio De-Embedding**

## User Manual







## Table of Contents

Statement	4
Safety Precaution	4
Introduction	5
Features	5
Package Contents	6
Specifications	7
Video Format Support Specifications	8
Interface Descriptions	9
IR Remote and Use	10
IR Cable Pin Assignment	11
EDID Management	11
Web GUI User Guide	12
Status Page	14
Matrix Page	14
Input Page	15
Output Page	16
Ext-Audio Page	17
CEC Page	17
Network Page	18
IP Setting:	18
Web Login Setting:	18
Set Network Defaults:	19
System Page	19
RS-232 Control Commands	21
Application Example	28
BZBGear Switch Control App	29
Tech Support	32
Limited Product Warranty Terms	32
Mission Statement	32
Copyright	32



## Statement

---

Please read these instructions carefully before connecting, operating, or configuring this product. Please save this manual for future reference.

## Safety Precaution

---

- To prevent damaging this product, avoid heavy pressure, strong vibration, or immersion during transportation, storage, and installation.
- The housing of this product is made of organic materials. Do not expose to any liquid, gas, or solids which may corrode the shell.
- Do not expose the product to rain or moisture.
- To prevent the risk of electric shock, do not open the case. Installation and maintenance should only be carried out by qualified technicians.
- Do not use the product beyond the specified temperature, humidity, or power supply specifications.
- This product does not contain parts that can be maintained or repaired by users. Damage caused by dismantling the product without authorization from BZBGear is not covered under the warranty policy.
- Installation and use of this product must strictly comply with local electrical safety standards.



## Introduction

---

The BG-8K-1616MA is a high-performance 48Gbps 8K 16×16 HDMI matrix switcher engineered for demanding residential and commercial AV installations. Supporting resolutions up to 8K@60Hz 4:2:0 12-bit, 4K@120Hz 4:4:4 12-bit, and 1080p240Hz it delivers exceptional image quality while fully supporting HDMI 2.1 features such as HDR10+, Dolby Vision, VRR, ALLM, QMS, QFT, and SBTM. Any of the 16 HDMI sources can be independently routed to any of the 16 HDMI displays, with per-output downscaling enabling seamless 8K-to-4K or 8K/4K-to-1080p compatibility.

Designed for flexible system integration, the BG-8K-1616MA supports advanced audio formats including LPCM 7.1, Dolby Atmos, Dolby TrueHD, Dolby Digital Plus, and DTS-HD Master Audio, while providing digital audio outputs for professional audio distribution. Control is made easy through front panel buttons, IR remote, RS-232, or TCP/IP via a Web GUI, making this matrix an ideal solution for multi-room video distribution, control rooms, and high-end AV environments.

## Features

---

- **HDMI 2.1 & HDCP 2.3 Compliance:** Ensures compatibility with the latest 8K sources and protected content.
- **16×16 HDMI Matrix Switching:** Independently route any of 16 HDMI sources to any of 16 HDMI displays.
- **Ultra-High-Resolution Video Support:** Supports up to 8K@60Hz 4:2:0 12-bit, 4K@120Hz 4:4:4 12-bit, and 1080p240Hz video formats.
- **48Gbps Video Bandwidth:** Provides full-bandwidth HDMI 2.1 performance for uncompromised video quality.
- **Advanced HDR Pass-Through:** Supports HDR, HDR10, HDR10+, and Dolby Vision for enhanced contrast and color depth.
- **Per-Output Downscaling:** Scales 8K to 4K or 8K/4K to 1080p on each HDMI output independently.
- **HDMI 2.1 Gaming Features:** Supports VRR, ALLM, QMS, QFT, and SBTM for smoother and more responsive playback.
- **Digital Audio Output:** Provides professional-grade digital audio for external amplification or audio systems.
- **Multi-Channel HD Audio Support:** Compatible with LPCM 7.1, Dolby Atmos, Dolby TrueHD, Dolby Digital Plus, and DTS-HD Master Audio.
- **Advanced EDID Management:** Optimizes compatibility between sources and displays.
- **Multiple Control Options:** Control via front panel buttons, IR remote, RS-232, or TCP/IP with Web GUI.



## Package Contents

---

- 1 × BG-8K-1616MA
- 1 × 24V/3.75A Locking Power Adapter
- 1 × AC Power Cord (1.5m)
- 1 × IR Remote
- 1 × 12V IR Wideband Receiver Cable (1.5m)
- 1 × RS-232 Serial Cable (1.5m, male to female head)
- 8 × 5-pin 3.81mm Phoenix Connectors
- 8 × Machine Screws (KM3\*4)
- 2 × Mounting Ears



## Specifications

<b>Technical</b>	
HDMI Compliance	HDMI 2.1
HDCP Compliance	HDCP 2.3
Video Bandwidth	1200MHz/48Gbps
Video Resolution	8K@60Hz 4:2:0 12-bit, 4K@120Hz 4:4:4 12-bit, and 1080p240Hz
Color Space	RGB_4:4:4, YCbCr_4:4:4, YCbCr_4:2:2, YCbCr_4:2:0
Color Depth	8/10/12-bit
HDR Formats	HDR, HDR10, HDR10+, Dolby Vision, HLG
Audio Formats	<b>HDMI In/Out:</b> LPCM 2.0, Dolby Digital/Plus/EX, Dolby True HD, Dolby Atmos, DTS, DTS-EX, DTS-96/24, DTS High Res, DTS-HD Master Audio, DSD  <b>Digital Audio Outputs</b>
ESD Protection	Human body model — ±8kV (Air-gap discharge) & ±4kV (Contact discharge)
<b>Connection</b>	
Input ports	16 × HDMI [Type A, 19-pin female]
Output ports	16 × HDMI [Type A, 19-pin female] 16 × Digital Audio
Control ports	1 × TCP/IP [RJ45] 1 × RS-232 [D-Sub 9] 1 × IR EXT [3.5mm, Stereo Mini-jack]
<b>Mechanical</b>	
Housing	Metal Enclosure
Color	Black
Dimensions	17in (W) × 10in (D) × 1.8in (H) [440mm (W) × 256mm (D) × 44.5mm (H)]
Weight	10 lbs [4.54kg]
Power Supply	Input: AC 100 - 240V 50/60Hz, Output: DC 24V/3.75A (US/EU standard, CE/FCC/UL certified)
Operating Temperature	32 - 104°F / 0 - 40°C
Storage Temperature	-4 - 140°F / -20 - 60°C
Relative Humidity	20 - 90% RH (no-condensing)



## Video Format Support Specifications

---

<b>Resolution</b>	<b>Supported Frame Rates (Hz)</b>
640 × 480	60
720 × 480	59.94, 60
720 × 576	50
800 × 600	60
1024 × 768	60
1280 × 720	50, 59.94, 60
1280 × 1024	60
1360 × 768	60
1440 × 900	60
1440 × 1050	60
1600 × 1200	60
1920 × 1080	50, 59.94
1920 × 1080	23.98, 24, 25, 29.97, 30, 50, 59.94, 60
3840 × 2160	23.98, 24, 25, 29.97, 30, 50, 59.94, 60
4096 × 2160	23.98, 24, 25, 29.97, 30, 50, 59.94, 60



# Interface Descriptions

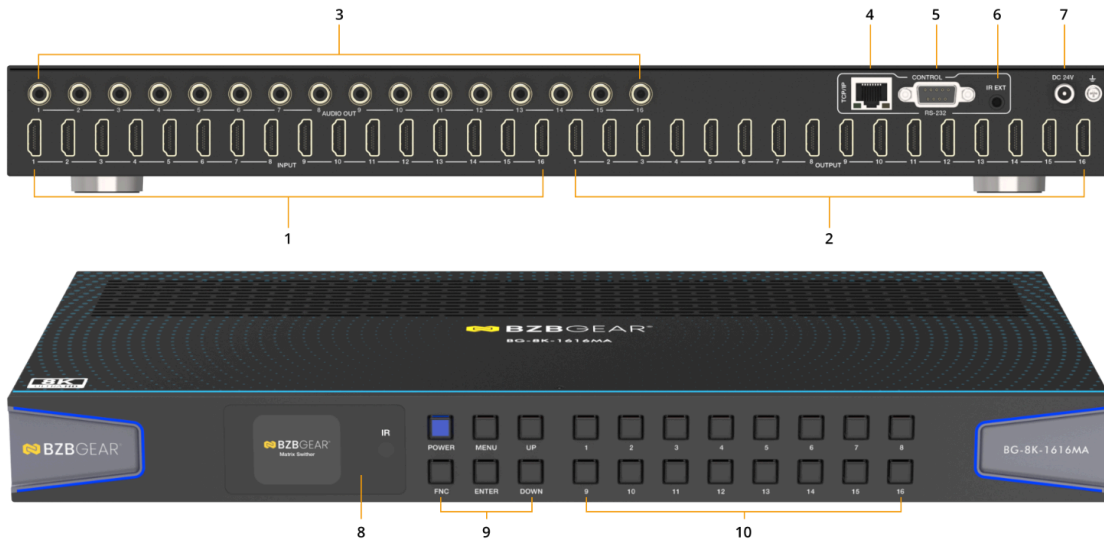

NO.	Name	Description
1	HDMI Input	HDMI input ports 1 - 16
2	HDMI Output	HDMI output ports 1 - 16
3	Audio Outputs	Digital audio outputs
4	TCP/IP	RJ45 ethernet connection for network control
5	RS-232	D-sub 9-pin connector for RS-232 commands
6	IR Ext	3.5mm IR receiver extension port
7	Power	DC24V/3.75A power port
8	OLED Display	Displays matrix status, power indicator, and IR receiver
9	Menu Navigation	Menu, Enter, Up, Down, Power, and Panel Lock
10	In/Out Buttons	Input/Output buttons 1 - 16



## IR Remote and Use

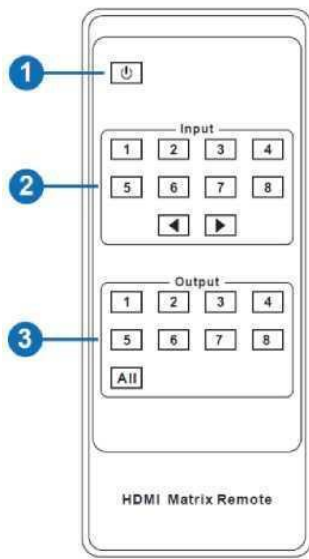

### 1. Power on or Standby:

Power on the matrix or set it to standby mode.

### 2. Input 1/2/3/4/5/6/7/8/16:

Select input channel.

◀ ▶: Select the last or next source.

### 3. Output 1/2/3/4/5/6/7/8/16:

Select output channel.

**All:** Select all output sources simultaneously. For example: Press the “All” button and then press input button “1”. Input “1” source content will be output to all display devices.

Press the output button first and then press the input button to select the corresponding input source. The matrix can select the input and output source via the IR remote. There are two ways to receive the IR remote signal.

**Direct:** The IR window on the LED display will receive the remote signal at a distance of up to 8 meters when the IR remote is directly facing the matrix or 5 meters when at an angle of  $\pm 45^\circ$ .

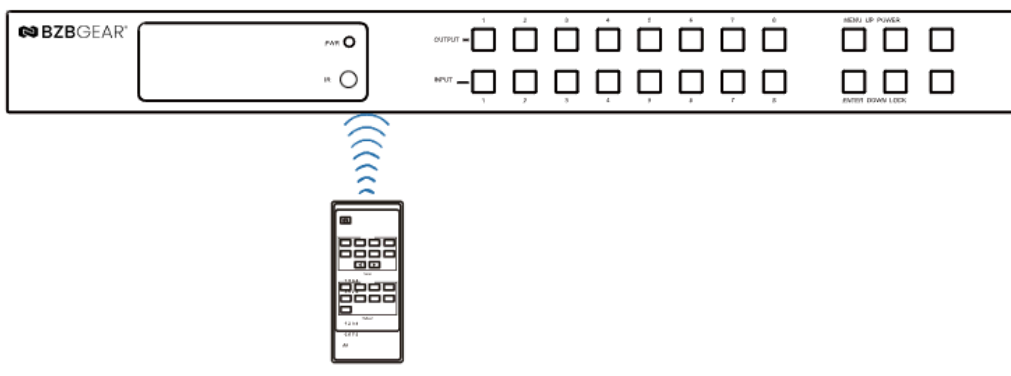

**IR Extension:** If the IR receiver window of the matrix is blocked or the Matrix is installed in a closed area out of infrared line of sight, the IR receiver extension cable can be inserted to the “IR EXT” port to receive the IR remote signal. The furthest distance when using the IR remote and extension cable is 5 meters when directly facing the IR receiver extension and 3 meters when the angle is  $\pm 45^\circ$ .



## IR Cable Pin Assignment

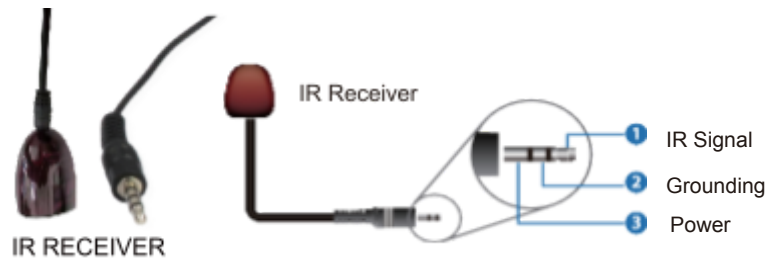

## EDID Management

The BG-8K-1616MA has 36 factory defined EDID settings, 3 user-defined EDID modes, and 8 copy EDID modes. You can select a defined EDID mode or copy EDID mode to an input port through front panel buttons, RS-232 control, or Web GUI.

**Button Panel:** When on the initial display screen, press the “MENU” button to enter the EDID setting interface, press “UP/DOWN” buttons to select an INPUT, and then press the “ENTER” button. EDID settings will be displayed. Press the “ENTER” button, and then press the “UP/DOWN” buttons to select the EDID mode you need. Press the “ENTER” button to confirm the selection.

**RS-232 Control:** Connect the Matrix to PC with a serial cable, then open a Serial Command tool on PC to send ASCII command “s input x EDID z!” to set EDID. For details, please refer to the “EDID Setting” in the ASCII command list section of this manual.

**Web GUI:** EDID management is located on the “Input” setting page of the Web UI.

Defined EDID settings list:

EDID Mode	EDID Description	EDID Mode	EDID Description
1	1080P,2.0CH	25	4K120(420)_HDR,2.0CH
2	1080P,5.1CH	26	4K120(420)_HDR,5.1CH
3	1080P,7.1CH	27	4K120(420)_HDR,7.1CH
4	4K30,2.0CH	28	4K120(444)_HDR,2.0CH
5	4K30,5.1CH	29	4K120(444)_HDR,5.1CH
6	4K30,7.1CH	30	4K120(444)_HDR,7.1CH
7	4K60(420),2.0CH	31	FRL10G_8K_HDR,2.0CH
8	4K60(420),5.1CH	32	FRL10G_8K_HDR,5.1CH
9	4K60(420),7.1CH	33	FRL10G_8K_HDR,7.1CH
10	4K60(444),2.0CH	34	FRL12G_8K_HDR,2.0CH



11	4K60(444),5.1CH	35	FRL12G_8K_HDR,5.1CH
12	4K60(444),7.1CH	36	FRL12G_8K_HDR,7.1CH
13	1080P_HDR,2.0CH	37	user1_EDID
14	1080P_HDR,5.1CH	38	user2_EDID
15	1080P_HDR,7.1CH	39	user3_EDID
16	4K30_HDR,2.0CH	40	copy out1
17	4K30_HDR,5.1CH	41	copy out2
18	4K30_HDR,7.1CH	42	copy out3
19	4K60(420)_HDR,2.0CH	43	copy out4
20	4K60(420)_HDR,5.1CH	44	copy out5
21	4K60(420)_HDR,7.1CH	45	copy out6
22	4K60(444)_HDR,2.0CH	46	copy out7
23	4K60(444)_HDR,5.1CH	47	copy out8
24	4K60(444)_HDR,7.1CH		

## Web GUI User Guide

The BG-8K-1616MA can be controlled via the built-in Web GUI as shown below.

**Step 1:** Obtain the current IP Address of the matrix.

**The default IP address is 192.168.1.100.**

Users can get the current IP address in two ways:

**1:** View the IP address via the panel buttons. On the initial OLED display, press the “MENU” button to enter the IP interface and then press “UP/DOWN” button to check the current IP address.

**2:** Users can get the IP address via RS-232 control. Send the command “r ipconfig!” through an ASCII Command tool and then you will get the feedback information as shown below:

```

IP Mode: Static
IP: 192.168.1.100
Subnet Mask: 255.255.255.0
Gateway: 192.168.1.1
TCP/IP port=8000
Telnet port=10
Mac address: 00:1C:91:03:80:01

```

IP:192.168.1.100 in the above figure is the IP Address of the Matrix.

For the details of ASCII control, please refer to the RS-232 Control Command section of this manual.



**Step 2:** Connect the TCP/IP port of the Matrix to a PC or network switch, and set the IP address of the PC to be in the same subnet as the Matrix.

**Step 3:** Input the IP address of the Matrix into your web browser on the PC to open the Web GUI.

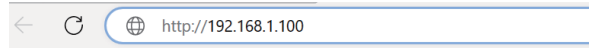

After opening the Web GUI, there will be a Login page, as shown below:

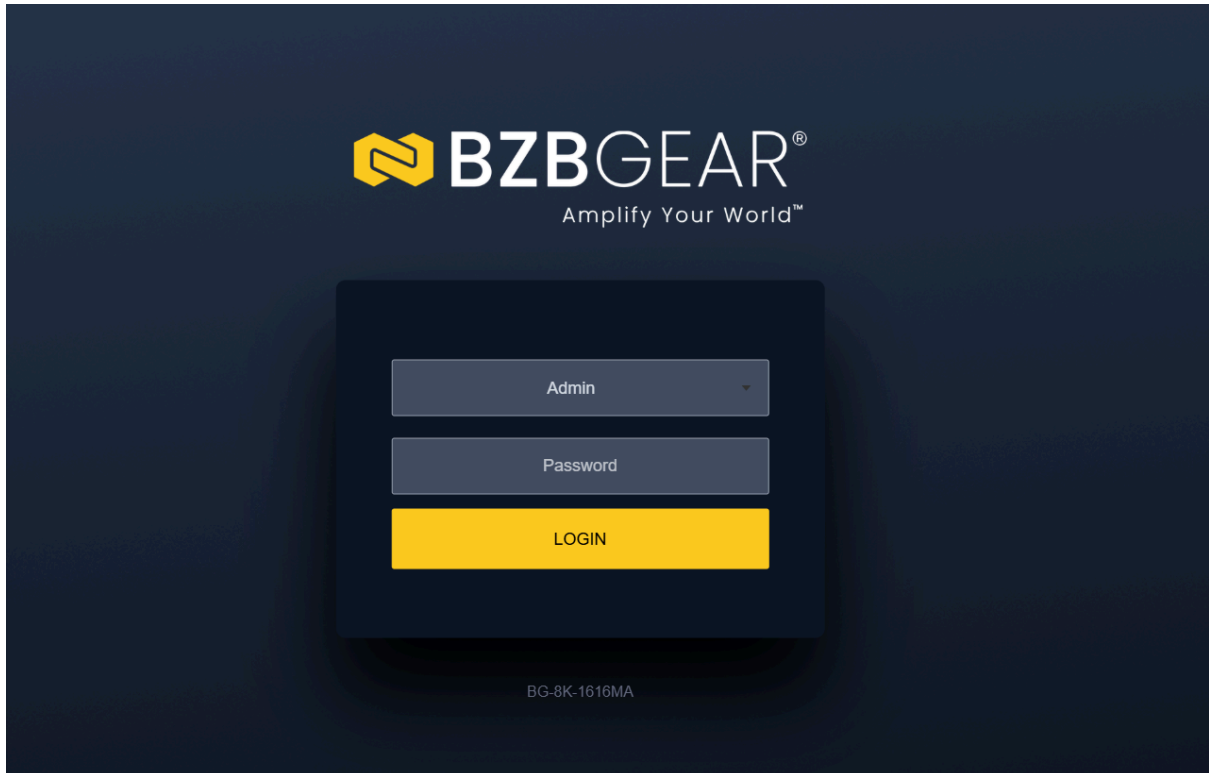

Select the Username from the list, enter the password, and then click the “LOGIN” button. The Status page will appear.

The default credentials are listed below:

Username: **Admin**

Password: **admin**



## Status Page

The Status page provides basic information about the Model, the installed firmware version, and the network settings of the device.

The screenshot shows the 'Status' page of the BZBGear BG-8K-1616MA. On the left is a navigation sidebar with options: Status (selected), Video, Matrix, Input, Output, Ext-Audio, CEC, Network, and System. Below the sidebar is contact information: 'Need Help? support@bzbgear.com (888) 499-9906'. The main content area is titled 'Status' and contains the following information:

Model	BG-8K-1616MA
Main Version / WEB Version	V1.00.05/V2.00.03
Sub1 Version	V1.05.12
Sub2 Version	V1.00.09
Sub3 Version	V1.00.02
Sub4 Version	V1.00.02
FPGA Version	V1.00.02
Hostname	IP-Module-60A4C
IP Address	192.168.30.95

## Matrix Page

The screenshot shows the 'Matrix' page of the BZBGear BG-8K-1616MA. The top right corner shows 'Admin', 'Power on', and 'Log out' buttons. The page is divided into two main sections: 'Switch' and 'Presets'.

**Switch Section:** A table with 11 rows and 2 columns: 'Outputs' and 'Inputs'. Each row shows an output number (1-11) and an input number (1-11) with a dropdown arrow.

Outputs	Inputs
Output 1	Input 1
Output 2	Input 2
Output 3	Input 3
Output 4	Input 4
Output 5	Input 5
Output 6	Input 6
Output 7	Input 7
Output 8	Input 8
Output 9	Input 9
Output 10	Input 10
Output 11	Input 11

**Presets Section:** A table with 8 rows and 4 columns: 'Presets Name', 'Presets Recall', 'Presets Save', and 'Presets Clear'. Each row represents a preset (1-8) and contains icons for recall (yellow), save (green), and clear (red).

Presets Name	Presets Recall	Presets Save	Presets Clear
Preset 1	[Recall]	[Save]	[Clear]
Preset 2	[Recall]	[Save]	[Clear]
Preset 3	[Recall]	[Save]	[Clear]
Preset 4	[Recall]	[Save]	[Clear]
Preset 5	[Recall]	[Save]	[Clear]
Preset 6	[Recall]	[Save]	[Clear]
Preset 7	[Recall]	[Save]	[Clear]
Preset 8	[Recall]	[Save]	[Clear]

1. **Switch:** Select the input signal source for an output.
2. **Presets:** Set, save, and clear presets.



# Input Page



**Input:** Input channel of the device.

**Active:** Indicates whether the channel is connected to a signal source. It is green if connected, and yellow if it is not connected.

**Name:** The input channel’s name. You can modify it by entering a name in the input box (max length is 31 characters) .

**EDID:** Indicates the current EDID of the device. Click the drop-down menu to select other EDID settings.

**Load EDID to user memory:** Set EDID for the User. Click the “Browse” button, then select the bin file. If you select the wrong EDID file, there will be a prompt, as shown in the following figure:

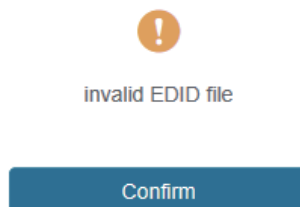

Be sure to select the correct file, select “User 1” or “User 2”, and then click “Upload”. After successful uploading the system will prompt as follows:



Upload Successful!

Confirm

**Download EDID to your computer:** Click the drop-down box of “Select EDID File” to select the corresponding input channel. Then click “Download” to download the corresponding EDID file.

## Output Page

Outputs	Cable	Name	Video Scaler	HDR Conversion	HDCP	ARC	Stream
HDMI 1	●	Output 1	Auto(Follow Sink)	Auto(Follow Sink)	Follow Sink	OFF ON	OFF ON
HDMI 2	●	Output 2	Auto(Follow Sink)	Auto(Follow Sink)	Follow Sink	OFF ON	OFF ON
HDMI 3	●	Output 3	Auto(Follow Sink)	Auto(Follow Sink)	Follow Sink	OFF ON	OFF ON
HDMI 4	●	Output 4	Auto(Follow Sink)	Auto(Follow Sink)	Follow Sink	OFF ON	OFF ON
HDMI 5	●	Output 5	Auto(Follow Sink)	Auto(Follow Sink)	Follow Sink	OFF ON	OFF ON
HDMI 6	●	Output 6	Auto(Follow Sink)	Auto(Follow Sink)	Follow Sink	OFF ON	OFF ON
HDMI 7	●	Output 7	Auto(Follow Sink)	Auto(Follow Sink)	Follow Sink	OFF ON	OFF ON
HDMI 8	●	Output 8	Auto(Follow Sink)	Auto(Follow Sink)	Follow Sink	OFF ON	OFF ON
HDMI 9	●	Output 9	Auto(Follow Sink)	Auto(Follow Sink)	Follow Sink	OFF ON	OFF ON
HDMI 10	●	Output 10	Auto(Follow Sink)	Auto(Follow Sink)	Follow Sink	OFF ON	OFF ON
HDMI 11	●	Output 11	Auto(Follow Sink)	Auto(Follow Sink)	Follow Sink	OFF ON	OFF ON

**Outputs:** Output channel of the device. “All Output” is available to set all outputs to a single input/source.

**Cable:** Indicates the connection status of output ports. When the output port is connected to the display it will show green, otherwise, it will be yellow.

**Name:** The output channel’s name. You can modify it by entering the corresponding name (max length: 31 characters) in the input box.

**Video Scaler:** Click the drop-down menu and set the video scaler mode.

**HDR Conversion:** Click the drop-down menu and set the video HDR conversion mode.

**HDCP:** Click the drop-down menu and set the HDCP for current device output.

**ARC:** Turn on/off the ARC function of the output device.

**Stream:** Turn on/off the output stream.



## Ext-Audio Page

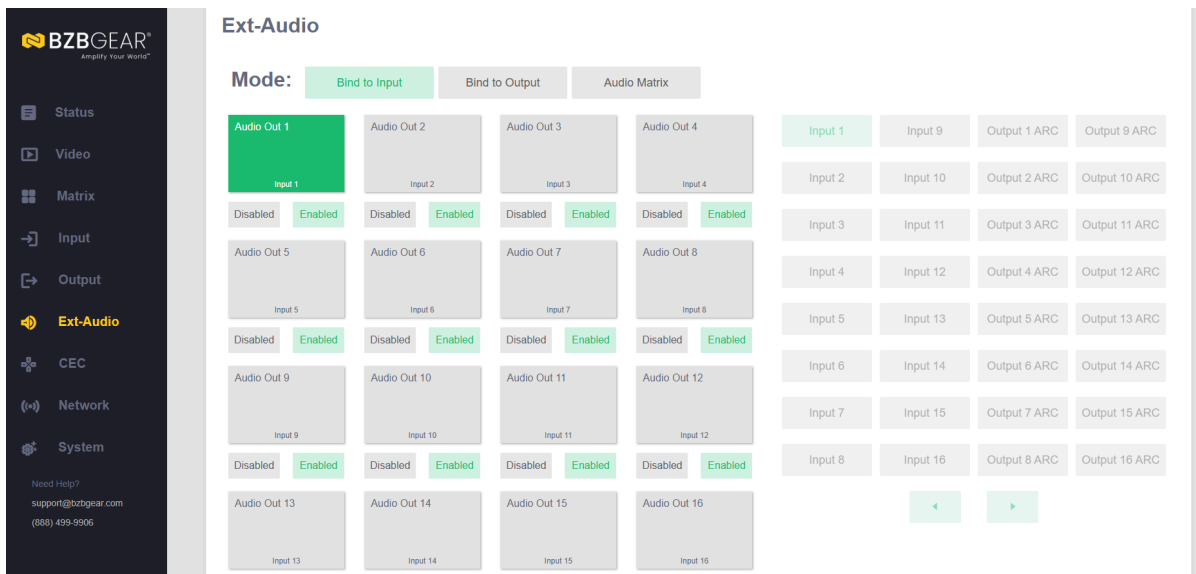

**Mode:** Click and select the audio mode. The audio sources can't be selected in Bind to Input / Bind to Output modes.

In Audio Matrix mode, you can perform the following:

- Select any audio source or ARC audio.
- Enable/disable any de-embedded audio.
- Switch to the previous or next audio source via the < / > arrows.

## CEC Page

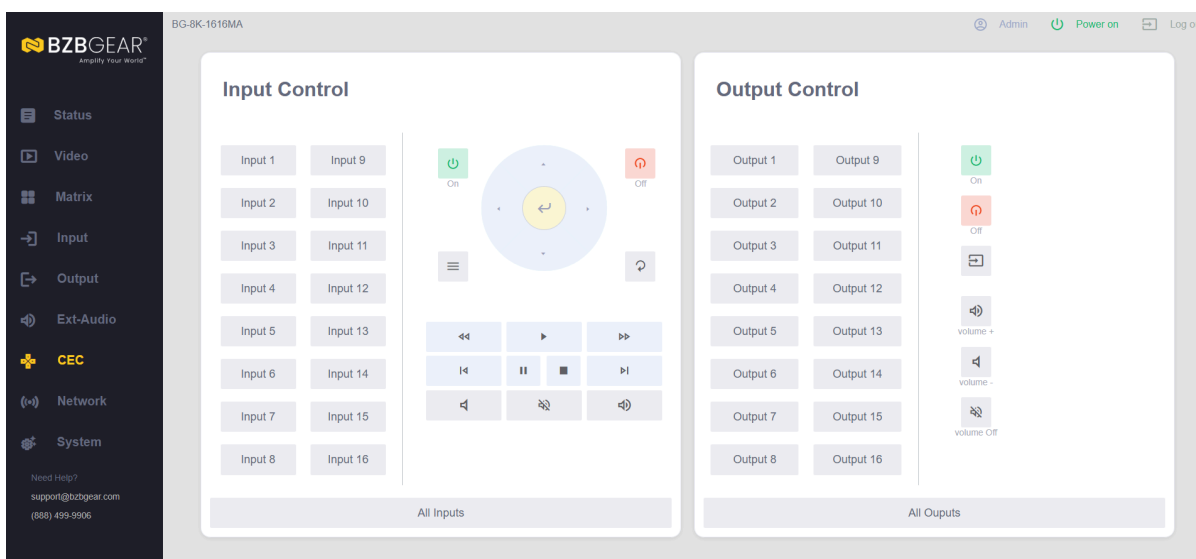

**Input Control:** Control the operation of each input source by clicking the icons on the page



if they are compatible.

**Output Control:** Control the operation of each display, such as power on/off, volume +/-, active source switching, etc. if they are compatible.

## Network Page

### IP Setting:

- Modify the IP Mode/IP Address/Gateway/Subnet Mask/Telnet Port as required, click “Save” to save the settings.
- After modification, if the Mode is set to “Static”, it will switch to the corresponding IP Address; if the Mode is set to “DHCP”, it will automatically search and switch to the IP Address assigned by the router.

### Web Login Setting:

Click the “User” button, enter the correct “Old Password”, “New Password”, Confirm the new Password, and then click “Save”. After successful modification, there will be a prompt, as shown in the following figure:

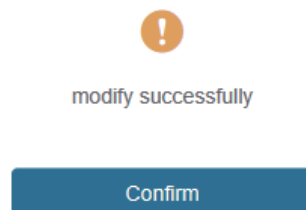

**Note:** Rules for changing passwords:



- (1) The password field cannot be empty.
- (2) The “New Password” can’t be the same as the “Old Password”.
- (3) The “New Password” and “Confirm Password” must be the same.

### Set Network Defaults:

Click “Set Network Defaults” to restore the unit to its factory default network settings. A prompt will appear as shown below:

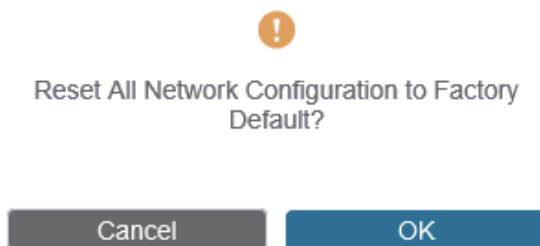

Click “OK” to search the IP Address again. After searching is completed, it will switch to the login page, the default network setting is completed.

## System Page

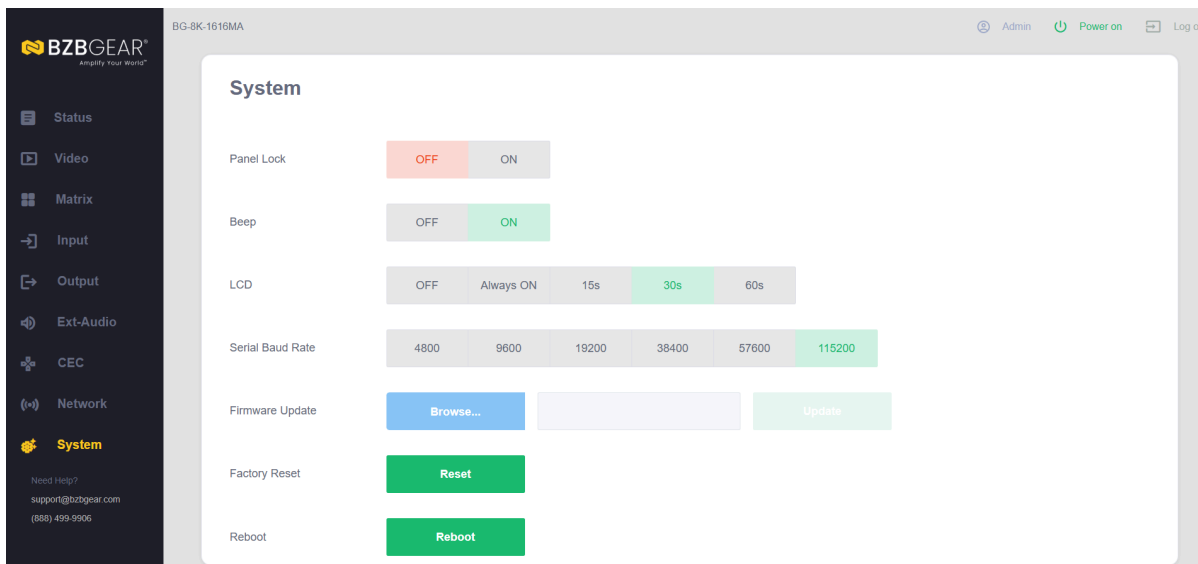

**Panel Lock:** Click “ON/OFF” to lock/unlock the panel buttons. “ON” indicates that panel buttons are unavailable; “OFF” indicates panel buttons are available.

**Beep:** Turn on/off the system beep.

**LCD:** You can turn on/off the LCD, and set the display duration time (Always ON/15s/30s/60s).



**Serial Baud Rate:** Click a value to set the Serial Baud Rate.

**Firmware Update:** Click “Browse” to select the update file, then click “Update” to complete the firmware update.

**Factory Reset:** Reset the unit to factory defaults by clicking “Reset”.

**Reboot:** Reboot the unit by clicking “Reboot”.

**Note:** After reset/reboot the unit will switch to the login page.



## RS-232 Control Commands

The **BG-8K-1616MA** supports RS-232 control. You will need a USB to serial cable with RS-232 DB9 male head. The RS-232 head of the serial cable is connected to the RS-232 control port on the rear of the Matrix, and the USB end of the serial cable is connected to a PC. The connection method is shown below:



Next, open a Serial Command tool on the connected PC to send ASCII commands to control the Matrix such as AccessPort or Docklight. The command list is shown below.

ASCII Command				
Serial port protocol. Baud rate: 115200, Data bits: 8bit, Stop bits:1, Check bit: 0				
x - Parameter 1, y - Parameter 2, ! - Delimiter				
Command Code	Function Description	Example	Feedback	Default Setting
System Setting				
help!	List all commands	help!		
status!	Get device current status	status!	Get the unit all status: power, beep, lock, in/out connection, video/audio crosspoint, edid, network status	
r type!	Get device model	r type!	16x16 HDMI2.1 Matrix	
r fw version!	Get Firmware version	r fw version!	MCU FW version x.xx.xx	
power z!	Power on/off the device, z=0~1 (z=0 power off, z=1 power on)	power 1!	power on System Initializing... Initialization Finished! MCU FW version x.xx.xx	
r power!	Get current power state	r power!	power on /power off	
s beep z!	Enable/Disable buzzer function, z=0~1 (z=0 beep off, z=1 beep on)	s beep 1!	beep on beep off	beep off



r beep!	Get buzzer state	r beep!	beep on / beep off	
s lock z!	Lock/Unlock front panel button,z=0~1 (z=0 lock off,z=1 lock on)	s lock 1!	panel button lock on panel button lock off	panel button lock off
r lock!	Get panel button lock state	r lock!	panel button lock on/off	
s lcd on time z!	Set LCD screen remain on time, z=0~4 (0:off 1:always,2:15s,3:30s, 4:60s)	s lcd on time 3!	lcd on 30 seconds	lcd on 30 seconds
r lcd mode!	Get the backlight status of lcd screen	r lcd mode!	lcd always on	
s logo1 *****!	Set the logo name displayed on the first line of LCD screen,the max character is 16	s logo1 Matrix Switch!	logo1:Matrix Switch	
reboot!	Reboot the device	reboot!	Reboot... 16x16 HDMI2.1 Matrix System Initializing... Initialization Finished! MCU FW version: x.xx.xx WEB GUI: x.xx.xx	
reset!	Reset to factory defaults	reset!	Reset to factory defaults 16x16 HDMI2.1 Matrix System Initializing... Initialization Finished! MCU FW version: x.xx.xx WEB GUI: x.xx.xx	
<b>Output Setting</b>				
s output y in source x!	Route input x source to output y (y=0~16, 0=all, x=1~16) x=1. input 1, x=2. input 2 x=3. input 3, x=4. input 4 x=5. input 5, x=6. input 6 x=7. input 7, x=8. input 8	s output 1 in source 1!	output1->input1	output1->input1 output2->input2 ..... output7->input7 output8->input8
r output y in source!	Get output y selected input source (y=0~16,0=all)	r output 1 in source!	output1->input1	
s output y hdcp x!	set output hdcp (y=0~16, x=1~5) x=1. HDCP 1.4 x=2. HDCP 2.2 x=3. Follow sink x=4. Follow source x=5. USER MODE	s output 1 hdcp 2!	output 1 HDCP: HDCP 1.4	Follow source



Command Code	Function Description	Example	Feedback	Default Setting
<b>Output Setting</b>				
r output y hdcp!	Get output y hdcp status. (y=0~16,0=all)	r output 1 hdcp!	output 1 HDCP: HDCP 1.4	
s output y stream x!	set output y stream enable/disable (y=0~16, 0=all, x=0~1) x=0. stream disable x=1. stream enable	s output 1 stream 1!	output 1 stream: Enable	Enable
r output y stream!	Get output y stream status. (y=0~16,0=all)	r output 1 stream!	output 1 stream: Enable	
s output y scaler x!	Set output y port scaler mode (y=0~16, 0=all, x=1~4) x=1. pass-through x=2. 8k->4k x=3. 8k/4k->1080p x=4. auto (follow sink EDID)	s output 1 scaler 2!	output 1 scaler mode: 8k->4k	pass-through
r output y scaler!	Get output y port scaler mode (y=0~16(0=all))	r output 1 scaler!	output 1 scaler mode: 8k->4k	
s output y hdr x!	Set output y port HDR to SDR mode (y=0~16, 0=all, x=1~3) x=1. pass-through x=2. HDR to SDR x=3. auto (follow sink EDID)	s output 1 hdr 2!	output 1 HDR mode: HDR to SDR	pass-through
r output y hdr!	Get output y port HDR to SDR mode (y=0~16 (0=all))	r output 1 hdr!	output 1 HDR mode: HDR to SDR	
s output y arc x!	Set output y ARC on/off (y=0~16, 0=all, x=0~1) x=0. off x=1. on	s output 1 arc 0!	output 1 arc: off	off
r output y arc!	Get output y ARC status (y=0~16 (0=all))	r output 1 arc!	output 1 arc: off	
<b>EDID Setting</b>				
s input x edid copy output y!	Set HDMI input x EDID copy from output y (x=0~16 0=all,y=1~16)	s input 1 edid copy output 1!	input 1 EDID: copy from output 1	
r input x EDID!	Get input x EDID mode (x=0~16,0=all)	r input 1 EDID!	FRL12G_8K_HDR,7.1CH	
s user x edid 00 FF FF ...!	Set user x EDID data (x=1~3) x=1. user1_EDID x=2. user2_EDID x=3. user3_EDID	s user 1 edid 00 FF FF FF FF ...!	user 1 EDID data: 00 FF FF FF FF FF FF 00 .....	
r user x edid!	Get user x EDID data (x=1~3)	r user 1 edid!	user 1 EDID data: 00 FF FF FF FF FF FF 00 .....	



Command Code	Function Description	Example	Feedback	Default Setting
<b>EDID Setting</b>				
s input x EDID z!	Set HDMI input x EDID mode (x=0~16,z=1~39) z=1. 1080P,2.0CH, z=2. 1080P,5.1CH, z=3. 1080P,7.1CH, z=4. 4K30,2.0CH, z=5. 4K30,5.1CH, z=6. 4K30,7.1CH, z=7. 4K60(420),2.0CH, z=8. 4K60(420),5.1CH, z=9. 4K60(420),7.1CH, z=10. 4K60(444),2.0CH, z=11. 4K60(444),5.1CH, z=12. 4K60(444),7.1CH, z=13. 1080P_HDR,2.0CH, z=14. 1080P_HDR,5.1CH, z=15. 1080P_HDR,7.1CH z=16. 4K30_HDR,2.0CH, z=17. 4K30_HDR,5.1CH, z=18. 4K30_HDR,7.1CH, z=19. 4K60(420)_HDR,2.0CH, z=20. 4K60(420)_HDR,5.1CH, z=21. 4K60(420)_HDR,7.1CH z=22. 4K60(444)_HDR,2.0CH, z=23. 4K60(444)_HDR,5.1CH, z=24. 4K60(444)_HDR,7.1CH, z=25. 4K120(420)_HDR,2.0CH, z=26. 4K120(420)_HDR,5.1CH,	s input 1 EDID 36!	input 1 EDID:FRL12G_8K_HDR,7.1CH	FRL12G_8K_HDR,7.1CH



	z=27. 4K120(420)_HDR,7.1CH z=28. 4K120(444)_HDR,2.0CH, z=29. 4K120(444)_HDR,5.1CH, z=30. 4K120(444)_HDR,7.1CH, z=31. FRL10G_8K_HDR,2.0CH, z=32. FRL10G_8K_HDR,5.1CH, z=33. FRL10G_8K_HDR,7.1CH z=34. FRL12G_8K_HDR,2.0CH, z=35. FRL12G_8K_HDR,5.1CH, z=36. FRL12G_8K_HDR,7.1CH, z=37. user1_EDID, z=38. user2_EDID, z=39, user3_EDID			
<b>Ext-audio Setting</b>				
s output y exa x!	Set output y ext-audio enable/ disable (y=0~16, 0=all, x=0~1) x=0. ext-audio disable x=1. ext-audio enable	s output 1 exa 1!	output 1 ext-audio: Enable	Enable
r output y exa!	Get output y ext-audio enable/ disable status (y=0~16, 0=all)	r output 1 exa!	output 1 ext-audio: Enable	

Command Code	Function Description	Example	Feedback	Default Setting
<b>Ext-audio Setting</b>				
s output exa mode x!	Set output ext-audio mode (x=0~2) x=0. bind to input mode x=1. bind to output mode x=2. matrix mode	s output exa mode 0!	output ext-audio mode: bind to input	bind to input
r output exa mode!	Get output ext-audio mode	r output exa mode!	output ext-audio moe: bind to input	
s output y exa in source x!	Route input source audio to output ext-audio y (y=0~16, x=1~16) x=1. input 1, x=2. input 2, x=3. input 3, x=4. input 4, x=5. input 5, x=6. input 6, x=7. input 7, x=8. input 8, x= 9. output 1 ARC, x=10 output 2 ARC, x=11. output 3 ARC, x=12. output 4 ARC, x=13. output 5 ARC, x=14. output 6 ARC x=15. output 7 ARC,	s output 1 exa in source 1!	output1 ext-audio ->input1	output1 ext-audio->input1 output2 ext-audio->input2 ..... output7 ext-audio->input7 output8 ext-audio->input8



	x=16. output 8 ARC			
r output y exa in source!	Get output y ext-audio secected input source (y=0~16, 0=all)	r output 0 exa in source!	output1 ext-audio->input1 output2 ext-audio->input2 ..... output7 ext-audio->output7 ARC output8 ext-audio->output8 ARC	
<b>CEC Setting</b>				
s cec in x on!	set input x power on by CEC, x=0~16 (0=all input)	s cec in 1 on!	input 1 power on	
s cec in x off!	set input x power off by CEC, x=0~16 (0=all input)	s cec in 1 off!	input 1 powe off	
s cec in x menu!	set input x open menu by CEC, x=0~16 (0=all input)	s cec in 1 menu!	input 1 open menu	
s cec in x back!	set input x back operation by CEC, x=0~16 (0=all input)	s cec in 1 back!	input 1 back operation	
s cec in x up!	set input x menu up operation by CEC, x=0~16 (0=all input)	s cec in 1 up!	input 1 menu up operation	
s cec in x down!	set input x menu down operation by CEC, x=0~16 (0=all input)	s cec in 1 down!	input 1 menu down operation	
s cec in x left!	set input x menu left operation by CEC, x=0~16 (0=all input)	s cec in 1 left!	input 1 menu left operation	

Command Code	Function Description	Example	Feedback
<b>CEC Setting</b>			
s cec in x right!	set input x menu right operation by CEC, x=0~16 (0=all input)	s cec in 1 right!	input 1 menu right operation
s cec in x enter!	set input x menu enter by CEC, x=0~16 (0=all input)	s cec in 1 enter!	input 1 menu enter operation
s cec in x play!	set input x play by CEC, x=0~16 (0=all input)	s cec in 1 play!	input 1 play operation
s cec in x pause!	set input x pause by CEC, x=0~16 (0=all input)	s cec in 1 pause!	input 1 pause operation
s cec in x stop!	set input x stop by CEC, x=0~16 (0=all input)	s cec in 1 stop!	input 1 stop operation
s cec in x rew!	set input x rewind by CEC, x=0~16 (0=all input)	s cec in 1 rew!	input 1 rewind operation
s cec in x mute!	set input x volume mute by CEC, x=0~16 (0=all input)	s cec in 1 mute!	input 1 volume mute
s cec in x vol-!	set input x volume down by CEC, x=0~16 (0=all input)	s cec in 1 vol-!	input 1 volume down
s cec in x vol+!	set input x volume up by CEC, x=0~16 (0=all input)	s cec in 1 vol+!	input 1 volume up
s cec in x ff!	set input x fast forward by CEC, x=0~16 (0=all input)	s cec in 1 ff!	input 1 fast forward operation
s cec in x previous!	set input x previous by CEC, x=0~16 (0=all input)	s cec in 1 previous!	input 1 previous operation
s cec in x next!	set input x next by CEC, x=0~16 (0=all input)	s cec in 1 next!	input 1 next operation
s cec hdmi out y on!	set hdmi output y power on by CEC, y=0~16 (0=all hdmi output)	s cec hdmi out 1 on!	hdmi output 1 power on
s cec hdmi out y off!	set hdmi output y power off by CEC, y=0~16 (0=all hdmi output)	s cec hdmi out 1 off!	hdmi output 1 power off
s cec hdmi out y mute!	set hdmi output y volume mute by CEC, y=0~16 (0=all hdmi output)	s cec hdmi out 1 mute!	hdmi output 1 volume mute
s cec hdmi out y vol-!	set hdmi output y volume down by CEC, y=0~16 (0=all hdmi output)	s cec hdmi out 1 vol-!	hdmi output 1 volume down



s cec hdmi out y vol+!	set hdmi output y volume up by CEC, y=0~16 (0=all hdmi output)	s cec hdmi out 1 vol+!	hdmi output 1 volume up
s cec hdmi out y active!	set hdmi output y active source by CEC, y=0~16 (0=all hdmi output)	s cec hdmi out 1 active!	hdmi output 1 active source
<b>Network Setting</b>			
r ipconfig!	Get the Current IP Configuration	r ipconfig !	IP Mode: Static IP: 192.168.1.100 Subnet Mask: 255.255.255.0 Gateway: 192.168.1.1 TCP/IP port=8000 Telnet port=10 Mac address: 00:1C:91:03:80:01

Command Code	Function Description	Example	Feedback
<b>Network Setting</b>			
r mac addr!	Get network MAC address	r mac addr!	Mac address: 00:1C:91:03:80:01
s ip mode z!	Set network IP mode to static IP or DHCP, z=0~1 (z=0 Static, z=1 DHCP)	s ip mode 0!	Set IP mode:Static. (Please use"s net reboot!" command or repower device to apply new config!)
r ip mode!	Get network IP mode	r ip mode!	IP mode: Static
s ip addr xxx.xxx.xxx.xxx!	Set network IP address	s ip addr 192.168.1.100!	Set IP address: 192.168.1.100 (Please use"s net reboot!" command or repower device to apply new config!) DHCP on, Device can't config static address, set DHCP off first.
r ip addr!	Get network IP address	r ip addr!	IP address:192.168.1.100
s subnet xxx.xxx.xxx.xxx!	Set network subnet mask	s subnet 255.255.255.0!	Set subnet Mask:255.255.255.0 (Please use"s net reboot!" command or repower device to apply new config!) DHCP on, Device can't config subnet mask, set DHCP off first.
r subnet!	Get network subnet mask	r subnet!	Subnet Mask:255.255.255.0
s gateway xxx.xxx.xxx.xxx!	Set network gateway	s gateway 192.168.1.1!	Set gateway: 192.168.1.1 (Please use"s net reboot!" command or repower device to apply new config!) DHCP on, Device can't config gateway, set DHCP off first.
r gateway!	Get network gateway	r gateway!	Gateway:192.168.1.1
s tcp/ip port x!	Set network TCP/IP port (x=1~65535)	s tcp/ip port 8000!	Set TCP/IP port:8000
r tcp/ip port!	Get network TCP/IP port	r tcp/ip port!	TCP/IP port:8000
s telnet port x!	Set network telnet port (x=1~65535)	s telnet port 23!	Set Telnet port:23
r telnet port!	Get network telnet port	r telnet port!	Telnet port:23
s net reboot!	Reboot network modules	s network reboot!	Network reboot... IP Mode: Static IP: 192.168.1.100 Subnet Mask: 255.255.255.0 Gateway: 192.168.1.1 TCP/IP port=8000 Telnet port=10 Mac address: 00:1C:91:03:80:01



# Application Example

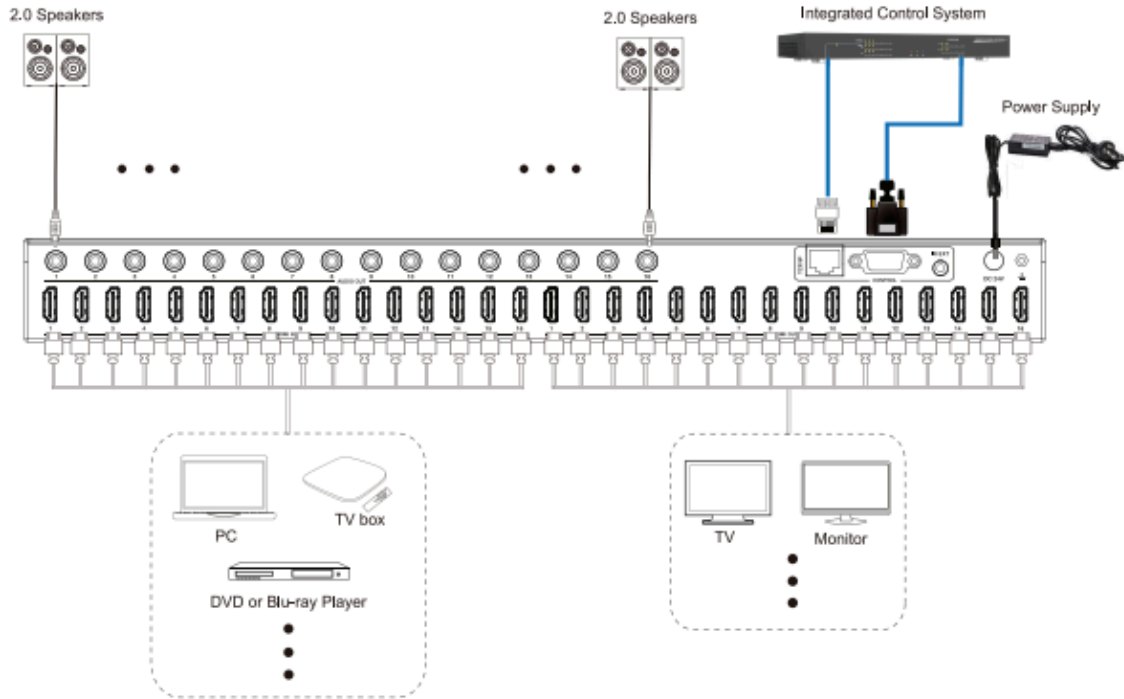



# BZBGear Switch Control App

## BG-Switch-Control | Quick User Guide



BZBGear Switch Control App



### Overview

The **BZBGear Switch Control App (BG-Switch-Control)** is a multi-platform network control application for compatible BZBGear matrix switchers. It provides centralized control of **video routing, audio routing, presets, and video wall configurations** through an intuitive graphical interface.

### Platform Compatibility

Supported operating systems:

- **Windows**
- **macOS**
- **iOS**
- **Android**
- All control devices must be connected to the **same local network** as the matrix switcher.

### Connection & Startup



1. Connect the BZBGear matrix switcher to the local network.
2. Connect the control device (PC, tablet, or smartphone) to the same network.
3. Launch the **BG-Switch-Control App**.



4. Select the correct product from the (Add Device) drop-down list
5. Fill in the device information (IP address, name, etc.)

### Matrix Switching



- Rename input and output sources (Optional)
- Press and hold an input source.
- Drag the input from the **Inputs panel** to the desired output.
- Release to complete the assignment.
- A single input can be routed to **multiple outputs simultaneously**.

### Preset Management

Presets allow quick saving and recall of system configurations.

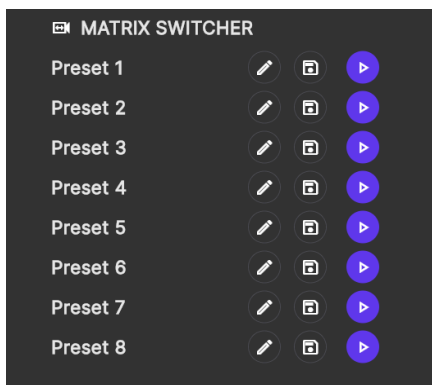

1. Configure routing or video wall settings.
2. Select **Save as Preset**.
3. Assign a preset number and name.
4. Recall presets at any time to instantly restore configurations.



## Video Wall Control

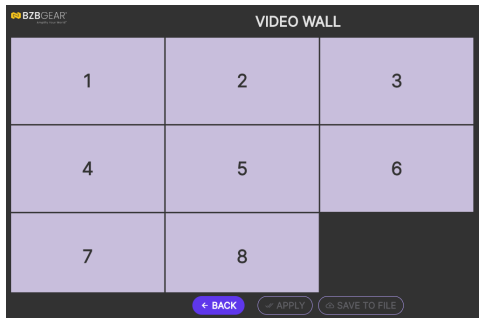

- Select **Create Video Wall**.
- Drag and arrange outputs into the desired layout.
- Select a source to span across the video wall.
- Select **Set Video Wall** to apply.
  - Video walls appear on the main screen and support **real-time switching** and **preset storage**.

## Pass-Through Mode

Pass-Through mode restores a direct, default input-to-output mapping.

This mode is useful for:

- System resets
- Testing
- Simplified routing

## Refresh Data

The **Refresh Data** function resynchronizes the app with the connected switcher.

Use this if configuration changes are made or if the interface appears out of sync.

## App Capabilities

- Matrix video routing
- Video wall creation and control
- Preset save and recall
- Audio matrix control (*supported devices*)
- Multi-user access with role-based permissions
- Multi-platform operation



## Tech Support

---

Have technical questions? We may have answered them already!

Please visit BZBGear's support page ([bzbgear.com/support](https://bzbgear.com/support)) for helpful information and tips regarding our products. Here you will find our Knowledge Base ([bzbgear.com/knowledge-base](https://bzbgear.com/knowledge-base)) with detailed tutorials, quick start guides, and step-by-step troubleshooting instructions. Or explore our YouTube channel, BZB TV ([youtube.com/c/BZBTVchannel](https://youtube.com/c/BZBTVchannel)), for help setting up, configuring, and other helpful how-to videos about our gear.

Need more in-depth support? Connect with one of our technical specialists directly:

<b>Phone</b>	<b>Email</b>	<b>Live Chat</b>
1.888.499.9906	<a href="mailto:support@bzbgear.com">support@bzbgear.com</a>	<a href="https://bzbgear.com">bzbgear.com</a>

## Limited Product Warranty Terms

---

Pro Line: 5-year warranty from the date of purchase for AV/Broadcasting products bought on or after August 1, 2024.

Essential Line: 3-year warranty from the date of purchase for AV/Broadcasting products bought on or after August 1, 2024.

Cables: Lifetime Limited Product Warranty.

For complete warranty information, please visit [bzbgear.com/warranty](https://bzbgear.com/warranty).

For questions, please call 1.888.499.9906 or email [support@bzbgear.com](mailto:support@bzbgear.com).

## Mission Statement

---

BZBGear is a breakthrough manufacturer of high-quality, innovative audiovisual equipment ranging from AVoIP, professional broadcasting, conferencing, home theater, to live streaming solutions. We pride ourselves on unparalleled customer support and services. Our team offers system design consultation, and highly reviewed technical support for all the products in our catalog. BZBGear delivers quality products designed with users in mind.

## Copyright

---

All the contents in this manual and its copyright are owned by BZBGear. No one is allowed to imitate, copy, or translate this manual without BZBGear's permission. This manual contains no guarantee, standpoint expression or other implies in any form. Product specification and information in this manual is for reference only and subject to change without notice.

**All rights reserved.** No reproducing is allowed without acknowledgement.