

# BG-4K-VP99PRO

**4K60Hz HDMI 9x9 Seamless Matrix and Signal Extender (70m)  
with Video Wall and Multiview Modes**

## User Manual







## Table of Contents

|   |    |
|---|----|
| Statement                                   | 4  |
| Safety Precaution                           | 4  |
| Introduction                                | 5  |
| Features                                    | 5  |
| Packing List                                | 5  |
| Specifications                              | 6  |
| Operation Controls and Functions            | 7  |
| Video Switching Operation                   | 9  |
| Matrix Switching Instructions               | 9  |
| Input/Output Channel Interface Instructions | 9  |
| Video Control                               | 10 |
| Mode Control                                | 14 |
| Audio Setting                               | 18 |
| EDID Setting                                | 19 |
| Setup Section                               | 21 |
| Info Section                                | 24 |
| Remote Control                              | 25 |
| WEB Control                                 | 26 |
| Network Control Instructions                | 26 |
| Video Interface                             | 28 |
| Network Interface Settings                  | 30 |
| Device Control Options                      | 31 |
| RS-232 Control                              | 33 |
| IR System                                   | 34 |
| Application Diagram                         | 35 |
| BZBGear Switch Control App                  | 37 |
| Tech Support                                | 40 |
| Limited Product Warranty Terms              | 40 |
| Mission Statement                           | 40 |
| Copyright                                   | 40 |



## Statement

---

Please read these instructions carefully before connecting, operating, or configuring this product. Please save this manual for future reference.

## Safety Precaution

---

- To prevent damaging this product, avoid heavy pressure, strong vibration, or immersion during transportation, storage, and installation.
- The housing of this product is made of organic materials. Do not expose to any liquid, gas, or solids which may corrode the shell.
- Do not expose the product to rain or moisture.
- To prevent the risk of electric shock, do not open the case. Installation and maintenance should only be carried out by qualified technicians.
- Do not use the product beyond the specified temperature, humidity, or power supply specifications.
- This product does not contain parts that can be maintained or repaired by users. Damage caused by dismantling the product without authorization from BZBGear is not covered under the warranty policy.
- Installation and use of this product must strictly comply with local electrical safety standards.



## Introduction

---

The BG-4K-VP99PRO is a 9x9 HDMI 2.0 over CAT5/6/7 matrix switcher with 3x3 Video Wall and 9 source multiview capabilities. Experience the pinnacle of versatility and cutting-edge technology with this advanced HDMI matrix switcher, perfect for a wide range of professional AV installations.

With 9 HDMI inputs, 9 HDMI loop outs, 9 HDMI outputs, and 9 DSC outputs featuring Power over Cable (POC) support, seamless integration with multiple sources, displays, and audio systems is guaranteed. Additionally, for large-scale AV projects and installations, all HDMI sources can be extended up to 70m(229ft) over CAT6/7 with resolutions up to 4K60Hz 4:4:4.

## Features

---

- 9x HDMI input, 9x HDMI loopout, 9x HDMI output and 9x DSC output (POC)
- Resolutions up to HDMI 4K60Hz 4:4:4, deep color 12bit, bandwidth 10.2Gbps
- Transmit up to 70m using 4K@60hz with receivers
- Supports seamless matrix switching; video wall (max 3x3); preset setting, and multiview modes.
- Balanced Audio Extraction
- Control via front panel buttons, IR Remote, TCP/IP control, or RS232 commands.
- Built-in EDID (4K30Hz, 1080P)
- HDCP 2.2/1.4 compliant
- Can cascade with other units to create max 10x10 video wall,
- Video wall image control 180°rotation, mirror, and bezel adjustments.

## Packing List

---

- 1x Main Unit
- 9x Receivers
- 1x Power Cord
- 1x IR Remote Control
- 1x Main Unit Mounting Ears Kit
- 9x RX Unit Mounting Ears Kit
- 20x IR-TX & 20x IR-RX Cable Kit
- 11X Terminal Block Plugs



## Specifications

| <b>Technical Specifications</b> |  |
|---------------------------------|--|
| HDMI Input                      | 9 x HDMI In  |
| HDMI Output                     | 9 x HDMI loop out, 9 x HDMI Out                          |
| Audio output                    | Analog (Balanced audio)                                  |
| Video Format Supported          | 4K@60Hz/1080P/720P/576P/480P/480i                        |
| HDCP Compliant                  | HDCP 2.2 and HDCP 1.4                                    |
| Control Options                 | Panel button/Remote/TCP/IP/RS232                         |
| Audio Format Supported          | PCM, Dolby 5.1/7.1, DTS5.1/7.1 digital audio             |
| <b>Hardware Specifications</b>  |  |
| Operating Temperature Range     | -5 to +40°C / 23 to +104 °F                              |
| Storage Temperature Range       | -10 to +60°C / -14 to +140 °F                            |
| Operating Humidity Range        | 5 to 90 % RH (no condensation)                           |
| Power Consumption               | 138 Watts  |
| Dimensions                      | 1.5U Rack Design 21.5 x 17.5 x 2.75in [546 x 445 x 70mm] |
| Mass (Main Unit)                | 12.1 lbs [5.48 kg]                                       |



# Operation Controls and Functions

## Front Panel



1. OUTPUT AND INPUT 1~9 (When switching, press Output first, then press Input)
2. LED Display
3. Menu Buttons: UP/DOWN/LEFT/RIGHT/ENTER (Center)
4. Function buttons: Panel Lock, Power (Stand-By Mode)

| Button      | Control Operations   |
|-------------|--|
| Output 1-9  | Press the Output button to select the output, pressing again will cancel the selection; Long press will select all, pressing again will cancel selection.                            |
| Input 1-9   | After pressing the output button, press an input button to select the input (only after selecting the output can the input be selected) Long press an input to enter video wall mode |
| ENTER       | Enter menu   |
| UP Arrow    | UP   |
| DOWN Arrow  | DOWN   |
| LEFT Arrow  | Left, Back one tab   |
| Right Arrow | Right  |
| LOCK        | Long press(3s) to lock the button panel; long press again to unlock.   |



## Rear Panel

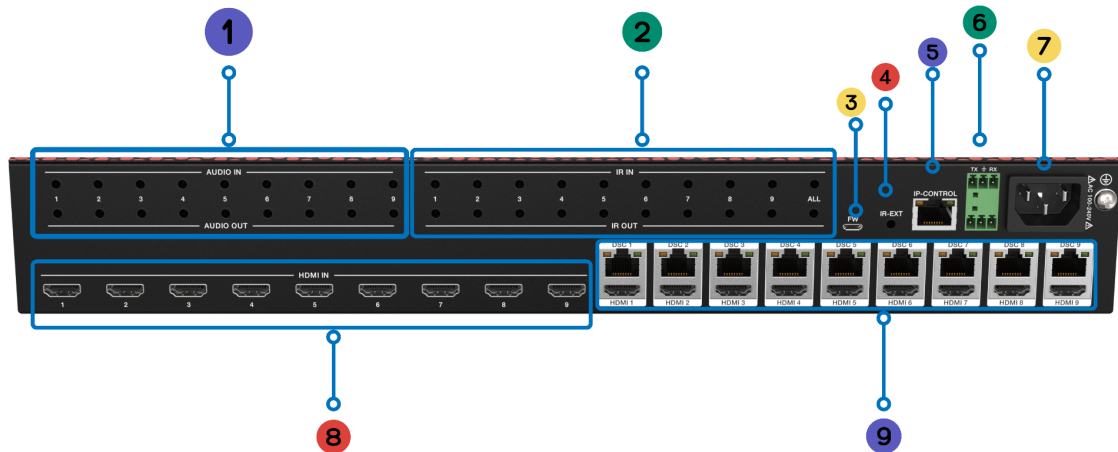

1. 3.5mm Audio Input and Output Ports
2. IR Input and Output Ports
3. FW Interface: Used for firmware upgrades
4. IR Extension Port
5. Ethernet Port: CAT5/6/7
6. RS-232: 2X 3-Pin Phoenix; Top - Control and firmware updates; Bottom - Log Access
7. DC Power Input: 24V
8. Input: HDMI 2.0 Input Ports
9. Output: CAT 5/6/7 Output Ports, HDMI 2.0 Loopout



## Video Switching Operation

### Matrix Switching Instructions

This matrix includes 9 channels that can be configured as either inputs or outputs according to your display requirements. It allows switching any input signal to any one output or to all outputs simultaneously.

Control operation is as follows:

|                    |   |   |   |   |   |   |   |   |   |
|--------------------|---|---|---|---|---|---|---|---|---|
| <b>O u t p u t</b> | 1 | 2 | 3 | 4 | 5 | 6 | 7 | 8 | 9 |
| <b>I n t p u t</b> | 1 | 1 | 1 | 1 | 1 | 1 | 1 | 1 | 1 |

### Input/Output Channel Interface Instructions

#### Switch an Input to an Output

Use the following operations to switch the input channel to the desired output channel.

1. **Switch Output 1 to Input 5**
  - **Operation:** Press the output number “1” + Press the input number “5” to complete the switch.
2. **Switch Outputs 2, 5, & 8 to Input 7**
  - **Operation:** Press the output numbers “2,” “5,” & “8” + Press the input number “7” to complete the switch.
3. **Switch All Outputs to Input 4**
  - **Operation:** Long press any output number + Press the input number “4” to complete the switch.
4. **Enter Video Wall Mode**
  - **Operation:** Long press any input button number (e.g., button 2) to enter video wall mode. All outputs will switch to input 2 simultaneously.



## Video Control

Press “MENU” on panel button to enter the main Menu interface:



1. Video: source switch
2. Mode: mode switch
3. Audio: audio setup
4. EDID: EDID setup
5. Preset: preset setup
6. INFO: info query
7. Setup: device setup

The video interface has 10 sub-menus: Output 1~9 and ALL.

Each sub-menu has 7 functions: switching(input/source), On/Off (video signal), PoC (power switch), Resolution (output), Rotate (180°), Mirror, Advanced.



Video Interface



## Video Switch

Switch any output to any input or switch all output to the same input

1. Choose "Video" in the menu and press "ENTER" button
2. Choose "Output1" and press "ENTER" button
3. Press "UP" and "DOWN" to select "Switching", press "ENTER"
4. Press "UP" and "DOWN" to select "Input"
5. Press "ENTER", switch video complete.

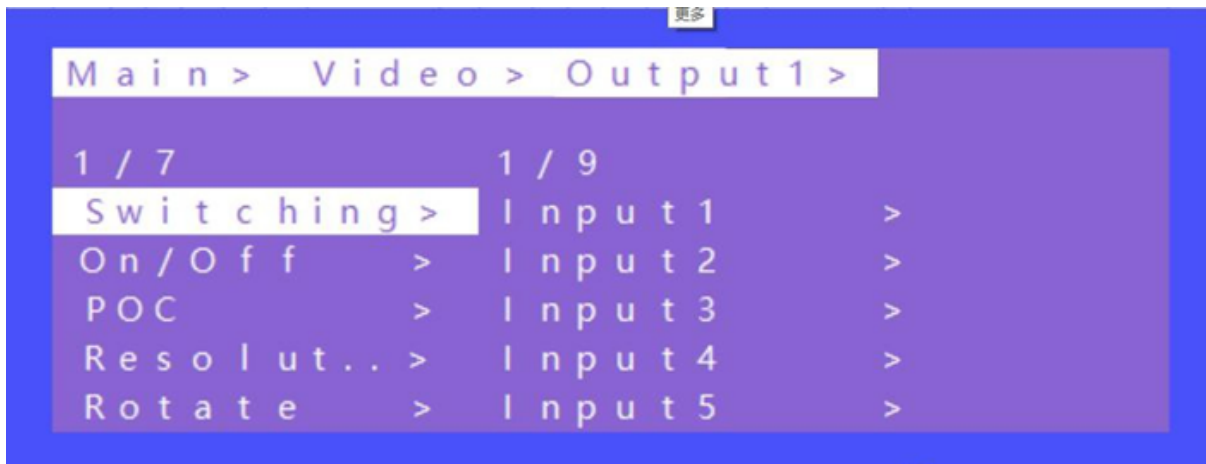

Switch Interface

## Video On/Off Control

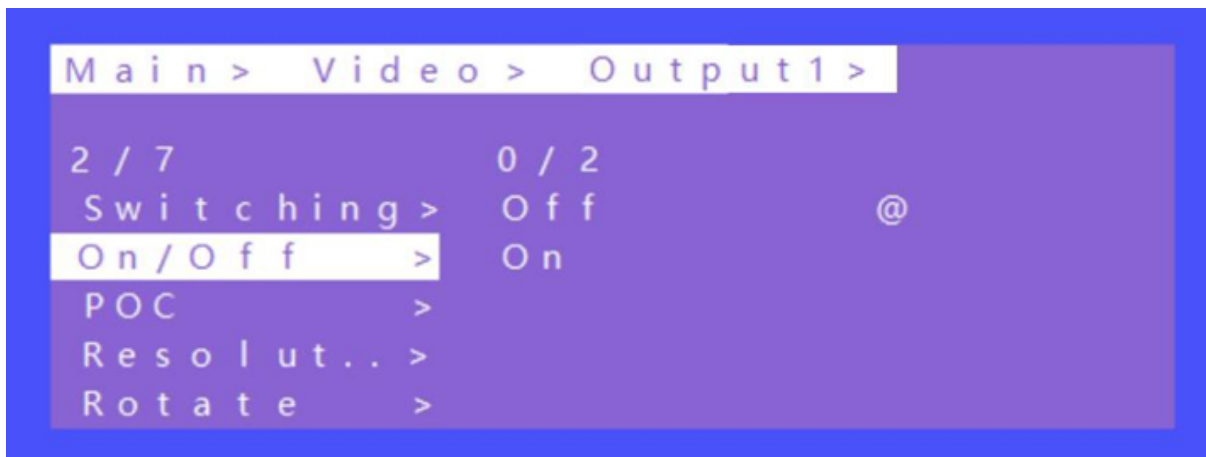

Video On/Off Interface



## PoC On/Off

---

Turn on/off any one-channel power supply for the receiver (12V 3A power).

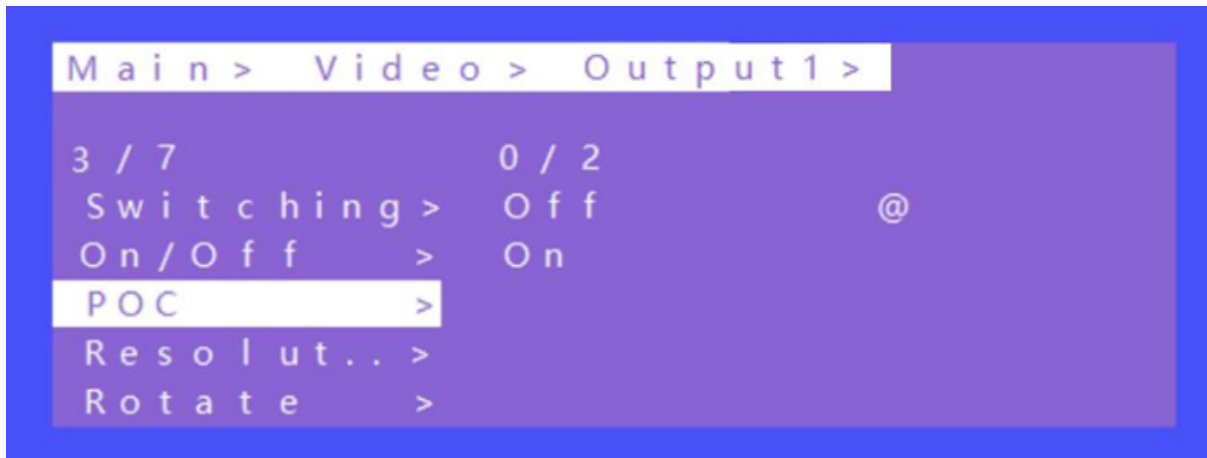

PoC On/Off Interface

## Output Resolution Selecting

---

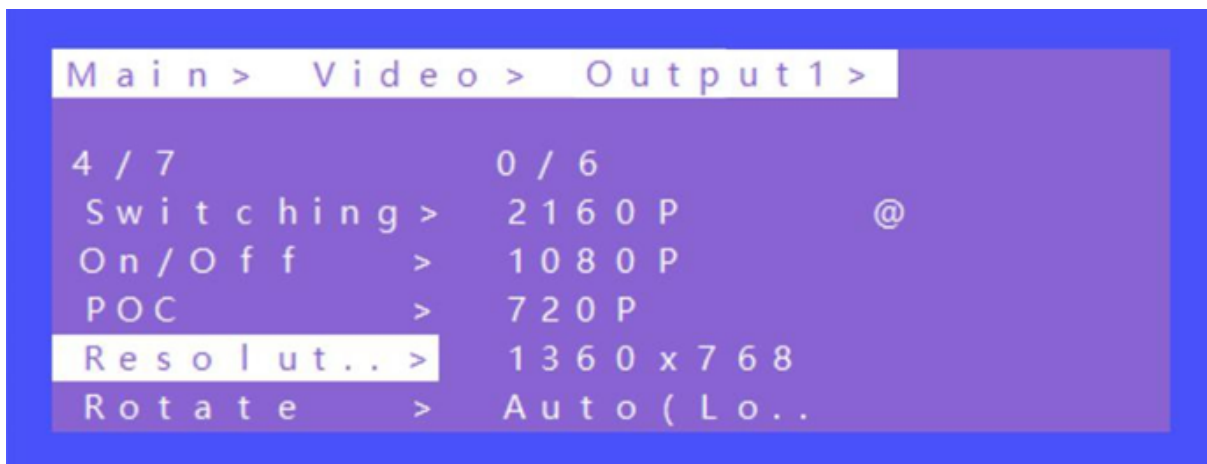

Resolution Format Interface

Output resolution options: 2160P(default), 1080P, 720P, 1360x768, AUTO (local), and AUTO (remote) .

(AUTO is the resolution supported by the automatic identification of the back-end TV).



## Rotate

---

Select any one or all outputs and rotate video (clockwise 180°)

```
Main > Video > Output1 >
5 / 7          0 / 2
Switching >   No           @
On/Off >     Yes
POC >
Resolut.. >
Rotate >
```

Rotate Interface

## Mirror function

---

Mirror for any one or all video outputs. Options: Normal (default, not mirrored), Only X (Mirror Horizontally), Only Y (Mirror Vertically), X and Y (Mirror Horizontally & Vertically, 180° rotate).

```
Main > Video > Output1 >
6 / 7          0 / 4
On/Off >     Normal       @
POC >       Only X
Resolut.. >  Only Y
Rotate >    X and Y
Mirror >
```

Mirror Interface



## Advanced Setup

---

Choose any one or all outputs for image color setup, including: Restore(reset all for color setup), Brightness, Contrast, Saturation, Hue, R\_Gain, G\_Gain, B\_Gain, R\_Offset,G\_Offset, and B\_Offset.

Each one can set 0~100, default is 50.



Advanced Interface

## Mode Control

---

The control interface for Mode has 2 sub-menus: Seamless Matrix and Video Wall.



Mode Interface



## Seamless Matrix

Seamlessly switch an input for all video outputs.  
 (P2P: output1 choose input1,output2 choose input2,etc.)

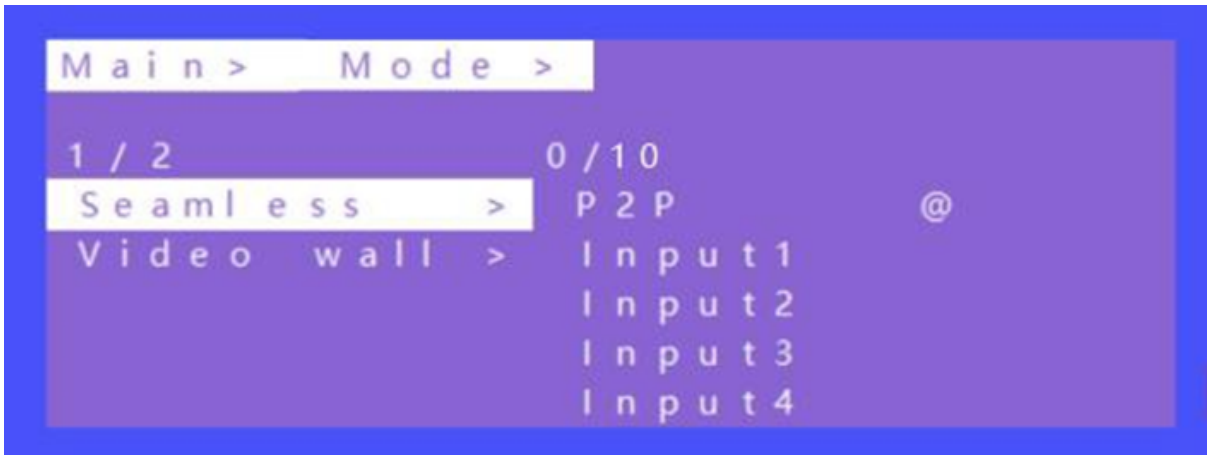

Seamless Matrix Interface

## Video Wall Mode

There are 4 sub-menus: Preset, Set Up (video wall size), Source (switch input), Offset (horizontal and vertical margin settings)

### A. Preset

There are 20 preset scenes in the Mode.

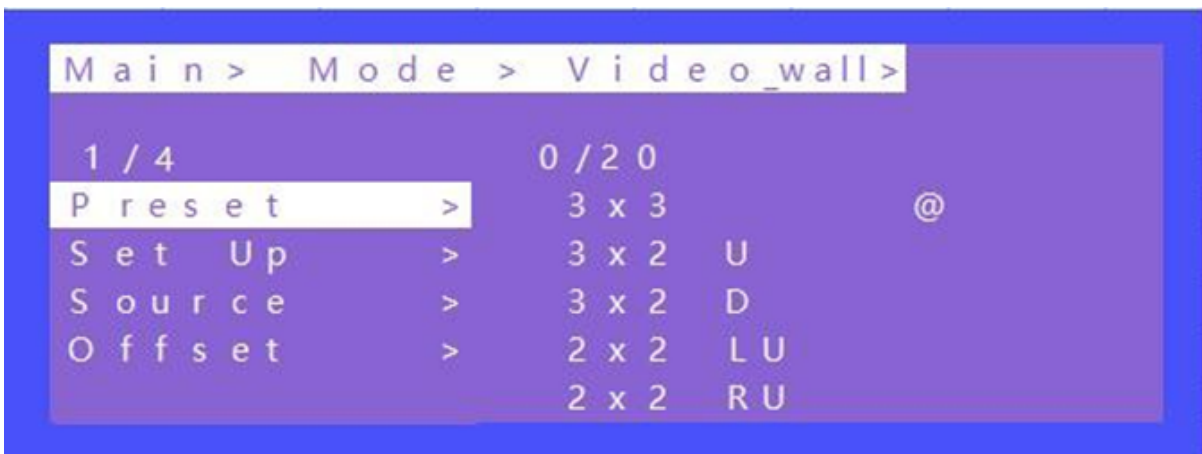

Explanation:

3x2 U means 3x2 Video wall on the TOP Side

2x2 LU means 2x2 Video wall is on the Left Upper side



B. Set Up

H\_NUM represents the number of screens on horizontal axis, option 1~10, default 1;

V\_NUM represents the number of screens on vertical axis, option 1~10, default 1;

Cascade represents device in which layer for the cascade connection, option 1~12, default 1;

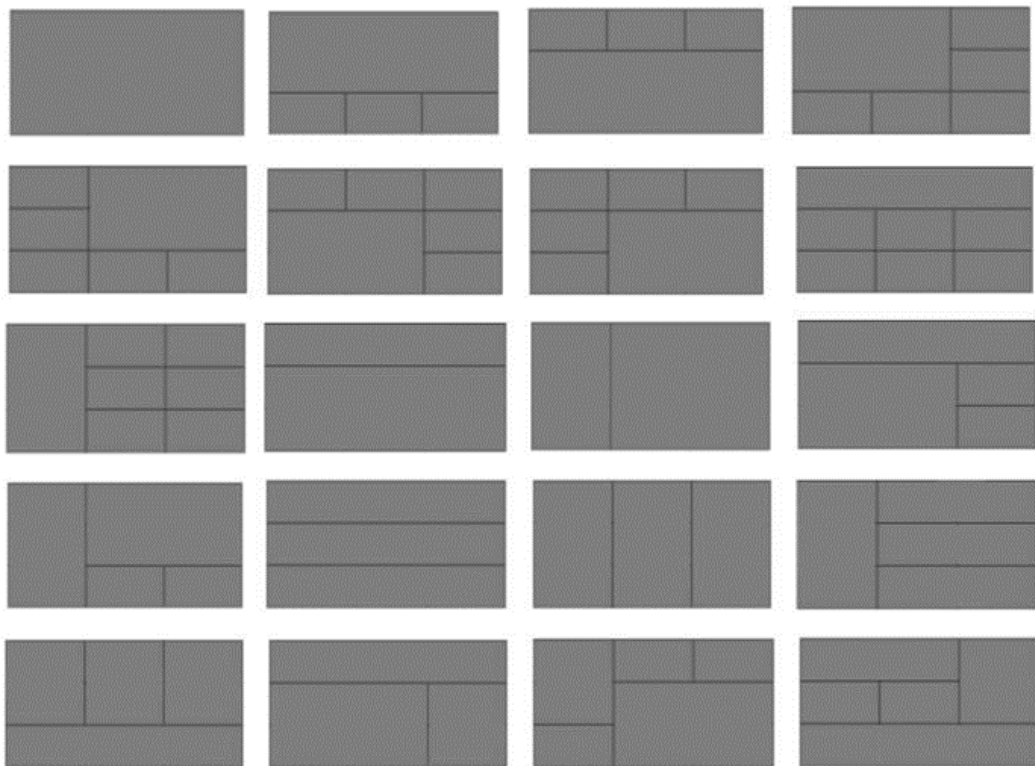



C. Source

To switch input source for video wall.

1. Use HDMI loop out port to connect next device for cascade when needed
2. Press “UP” and “DOWN” to select “Source”, press “ENTER”
3. Press “UP” and “DOWN” to select “Input1”
4. Press “ENTER”, switch video complete.

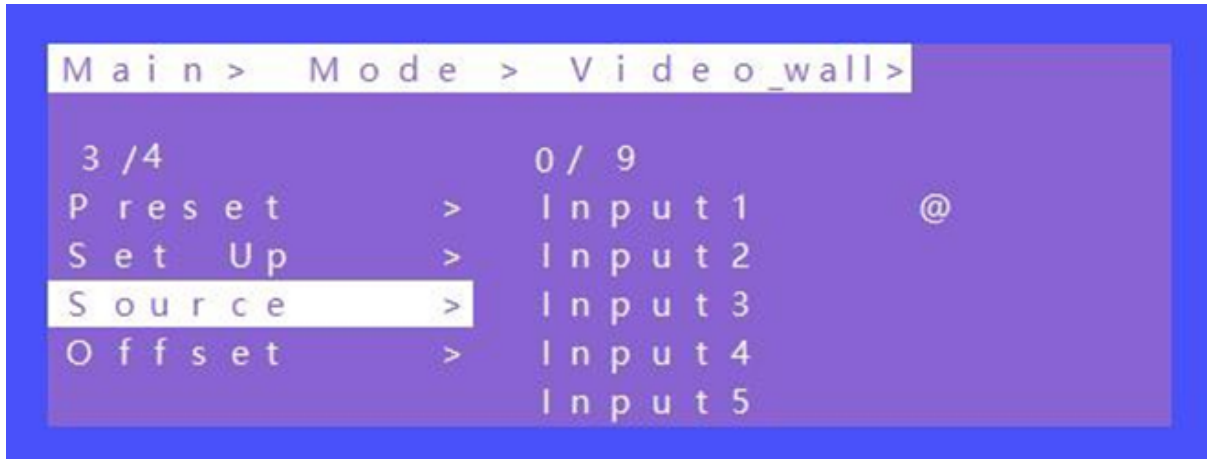

Source Interface

D. Offset

Choose all outputs for offset (horizontal and vertical margin settings) in video wall settings.

1. Press “UP” and “DOWN” to select “Offset” under video wall mode, press “ENTER”
2. Press “UP” and “DOWN” to select “X” or “Y”(301 options, 0~600, interval 2)
3. Press “ENTER”, Offset complete.

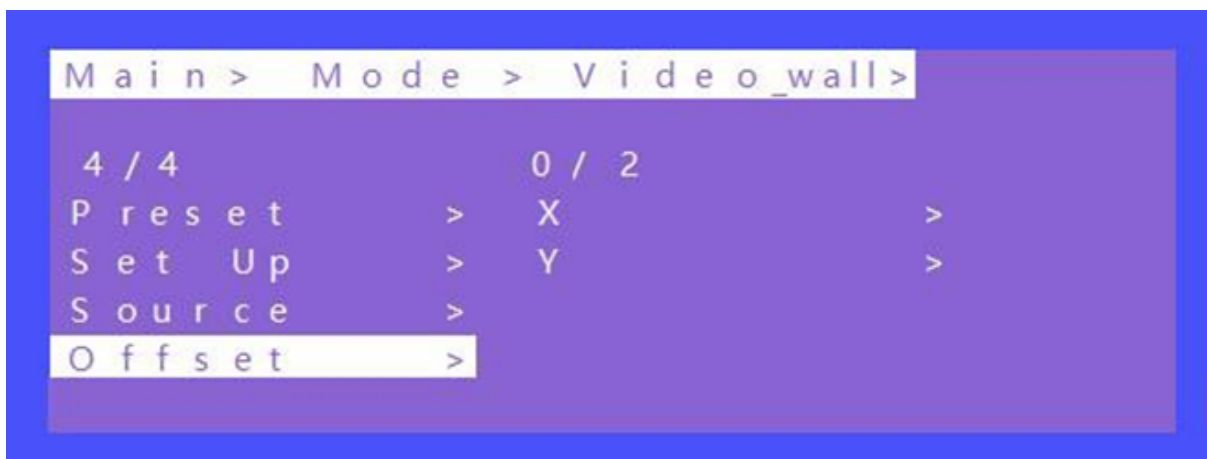



## Audio Setting

There are 10 sub-menus in the Audio control Interface:

1. OUT 1~9
2. ALL

The Audio Setting interface can set each output individually or all outputs at once. Mute, Unmute, or Delay can be selected for HDMI and Analog audio settings.

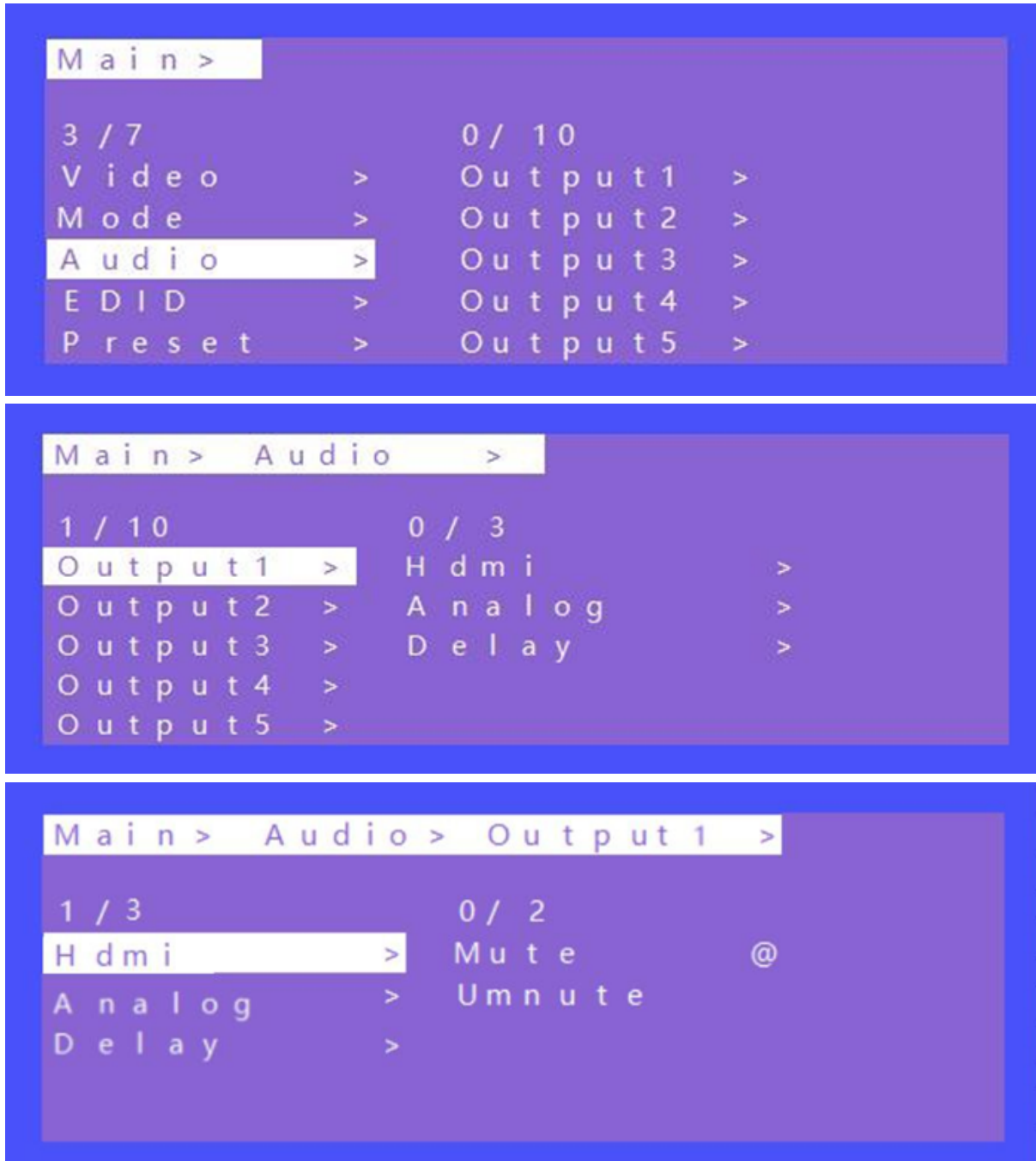

Audio Interface



## EDID Setting

Set each of the input ports' EDID, there are two resolutions of Built-In EDID: 4K30hz; 1080P;

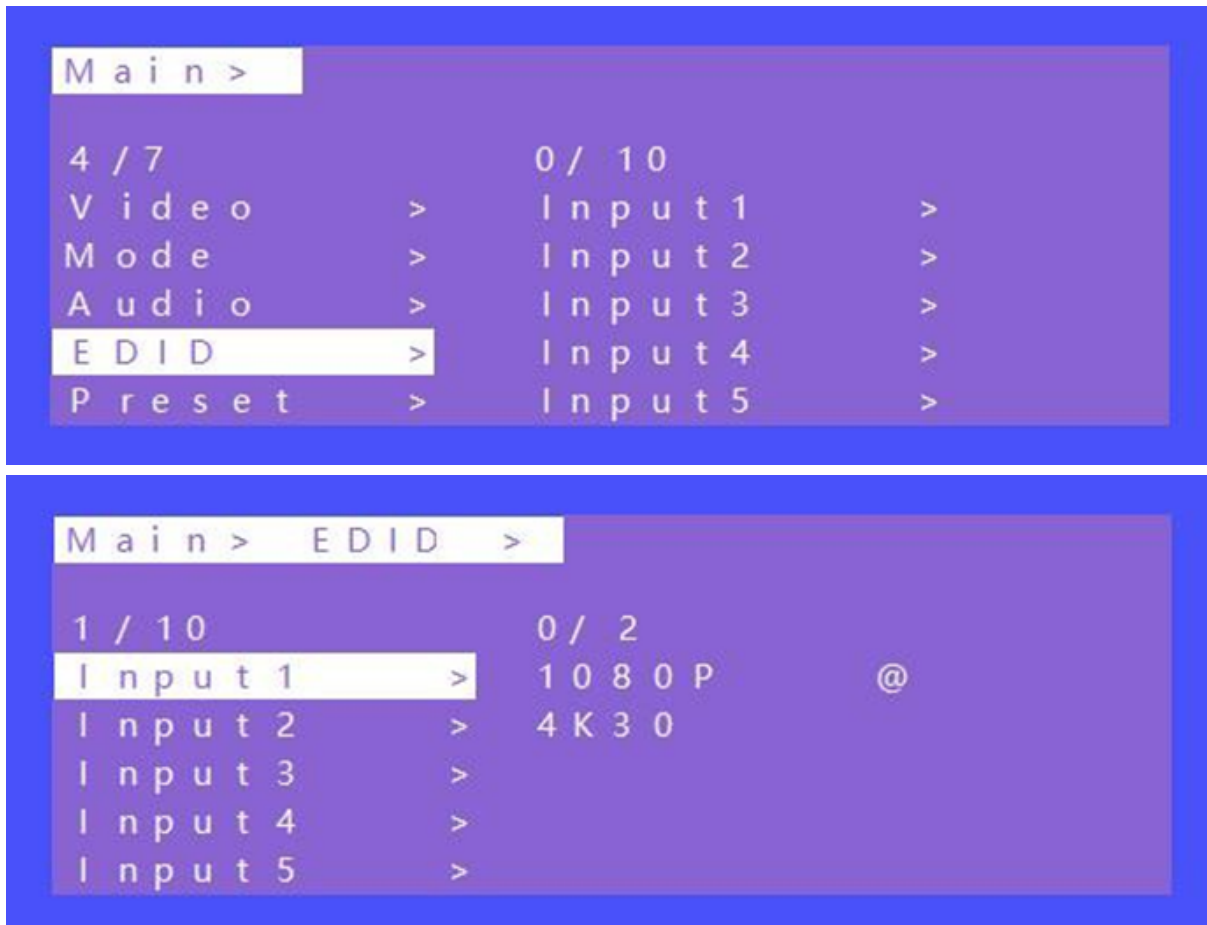

EDID Interface



## Preset Setting

1. Call: Call the preset video
2. Save: Save the preset settings
3. Clear: Remove the settings

There can be a total of 8 different presets. To modify the preset name users will need to login to the WEB interface. The name will then synchronize with the on screen menu.

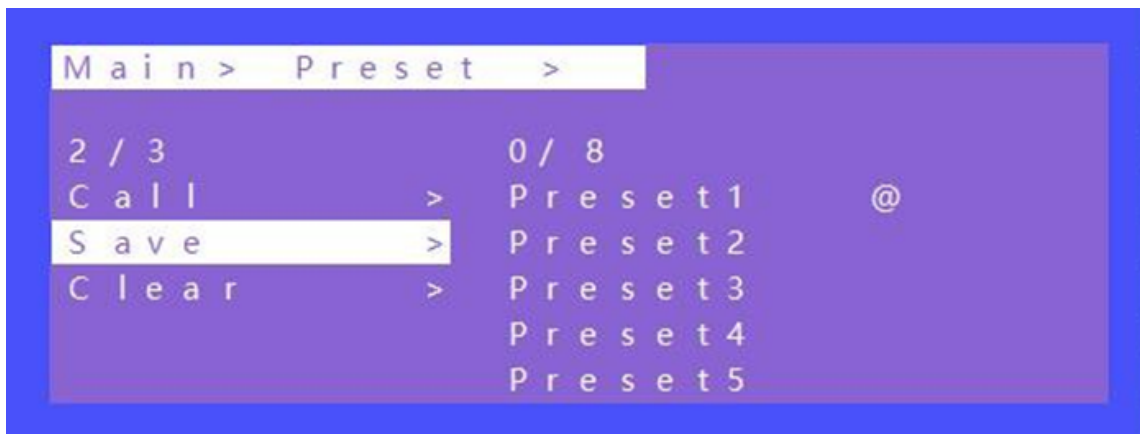
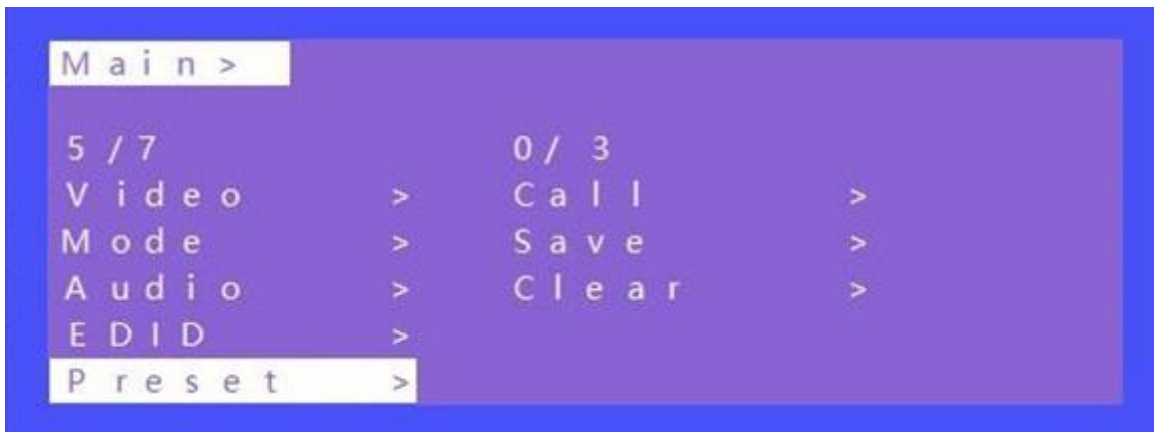

Preset Interface

(Note: Preset 1~8 default is P2P mode)



## Setup Section

### OSD Setting

OSD setting with 2 sub-menu:

Menu time: Timing OSD setting in Menu interface

Always means the OSD info will be showed all the time;

60s means the OSD info will be turn off after 60 seconds.

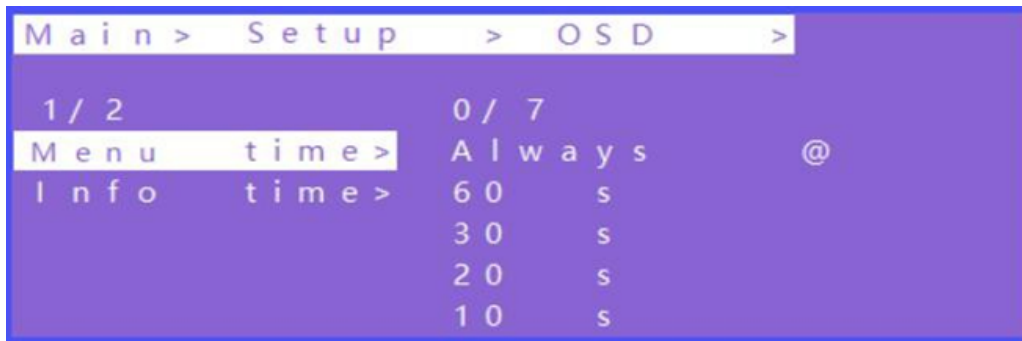

Info time: Timing OSD setting in Resolution information

In Info time setting, with an option "Never" means the Info OSD won't be showed.

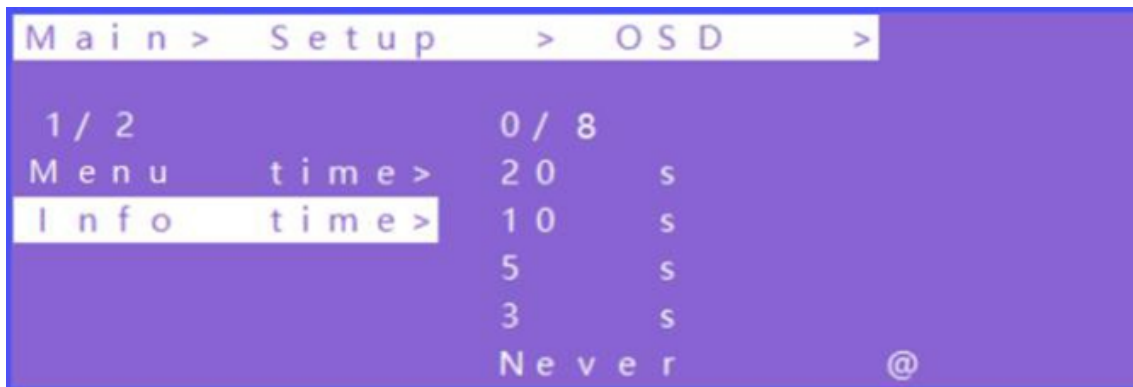

### Baud Rate Setting (Default: 115200)





### DHCP Setting (Default: DHCP Off)

---

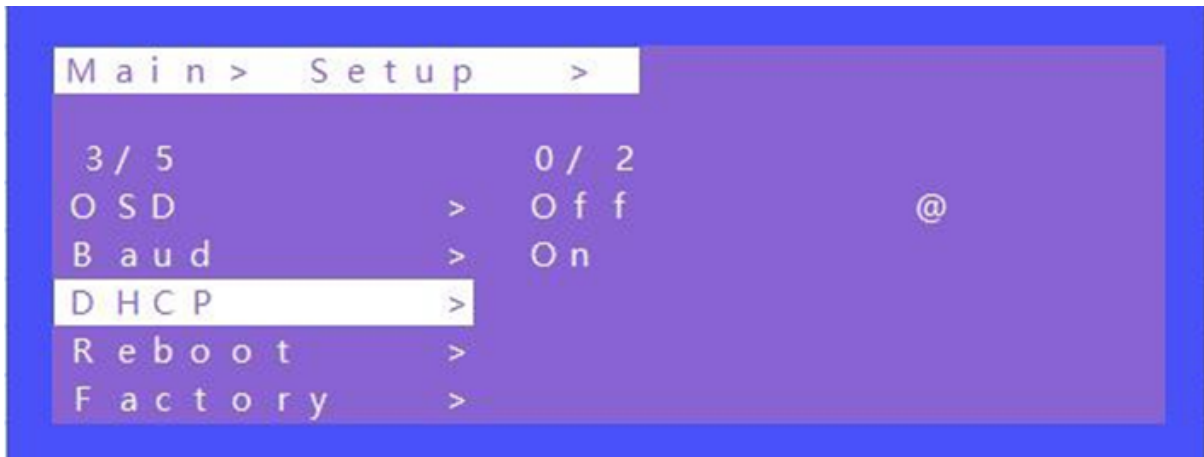

### Reboot Setting

---

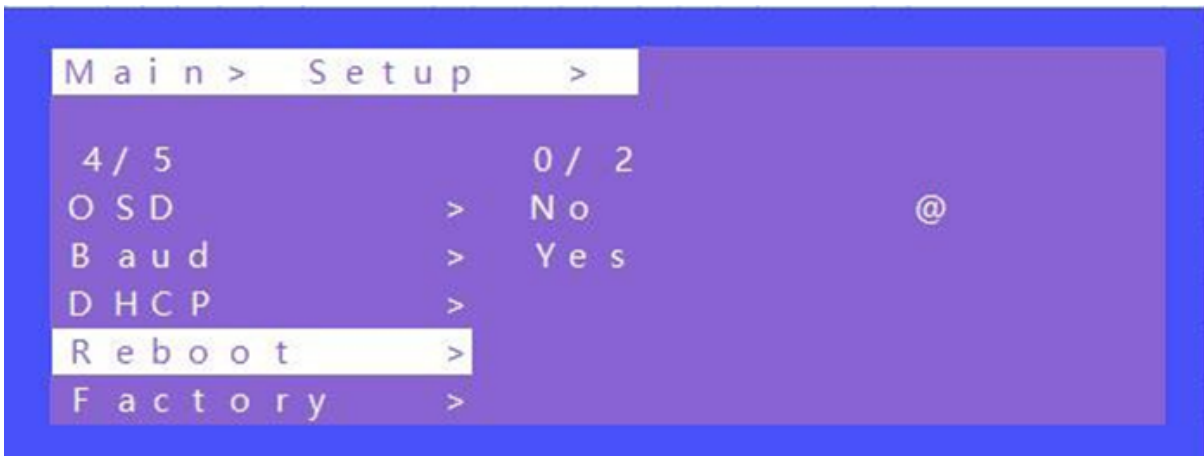



## Factory Setting

It is an initialization setting for the device function. There are two factory settings:

1. Factory-Run
2. Factory-User

Factory-Run is the recovery operation data. (Keep the Preset setting)

Factory-User can restore the factory settings for all settings.

```

Main > Setup >
5 / 5          0 / 2
O S D          >   R u n          >
B a u d        >   U s e r          >
D H C P        >
R e b o o t    >
F a c t o r y  >
    
```

```

Main > Setup > Factory > Run
1 / 2
No >   R e s e t   I n f o r m a t i o n
Yes >  1.V i d e o  2.A u d i o
          3.E D I D  4.S e t u p
    
```

```

Main > Setup > Factory > User
1 / 2
No >   R e s e t   I n f o r m a t i o n :
Yes >  1.V i d e o  2.A u d i o
          3.E D I D  4.S e t u p
          5.P r e s e t 6.N a m e
    
```



## Info Section

View device information such as network information and system information.





















The default IP address is 192.168.1.168.

```
Main > Info >
1 / 2
System > CO XXX
IP > Type XXX
Ver V 0.1.14
```

```
Main > Info >
2 / 2
System > DHCP OFF
IP > IP 192.168.1.168
MASK 255.255.255.0
GW 192.168.1.1
MAC 4658-4E92-6D76
```



## Remote Control

-  : Standby or power on
-  : Mute button
-  : Return to upper level
-  : Move to next level
-  : Picture off
-  : Page turn by 100 of the last sub-menu
-  : Page turn by 10 of the last sub-menu
-  : Menu
-  : All output
-  : Up
-  : Menu
-  : OK
-  : Enter
-  : Down
-  : Return or exit
-  : Menu
-  : When selecting Output, means Out1--out4  
When selecting Input, means In1--In4
-  : Preset
-  : (N/A)
-  : Point to Point 1-1, 2-2, 3-3, 4-4





## WEB Control

### Network Control Instructions

When the matrix is connected to a control device (such as a PC) through the TCP/IP network port, it can be controlled via ASCII/HEX commands or through a web-based GUI.

#### Control Options:

1. **Direct Control through TCP/IP Port:**
  - Connect the matrix directly to a control device using the TCP/IP port.
2. **Network Control:**
  - Connect the matrix and the control device over a network. Ensure both devices are on the same subnet, but with different last segments of their IP addresses.

#### Network Configuration:

- **Default IP Address of the Web Interface:** 192.168.1.168
- **Subnet Mask:** 255.255.255.0
- **Gateway:** 192.168.1.1
- **MAC Address:** XXX-XXX-XXXX (specific to the unit)

Ensure the matrix and control device are configured correctly to facilitate communication and control over the network.

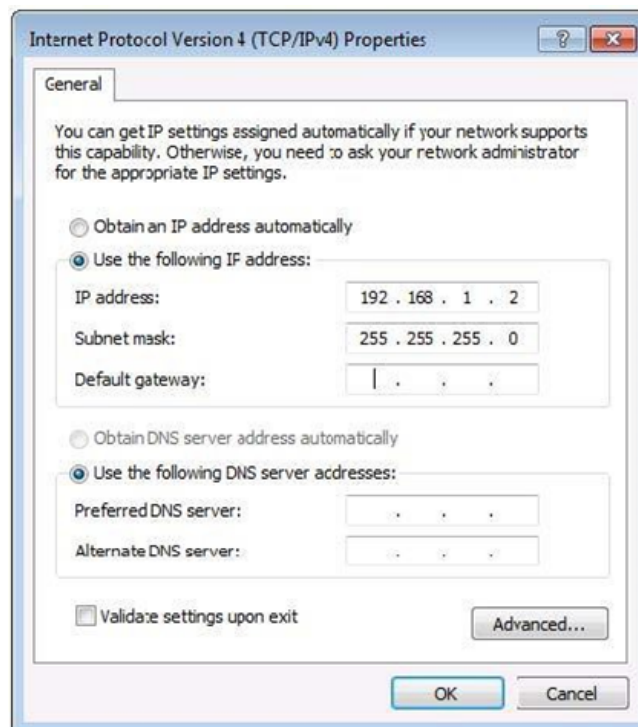



In your preferred web browser type in the default IP address of the unit or the one shown in the on-screen display if the unit was set to DHCP or previously configured.

Users will be directed to the login page of the device.

**BZBGear**<sup>®</sup>  
Solutions to Amplify Your World™

Username

Password 

Login

BG-4K-VP99PRO

#### LOGIN Interface

Enter in the default admin credentials shown below and click “Login” to access the user interface.

**Username:** admin

**Password:** admin



# Video Interface

## A. Matrix Interface

**Matrix Switcher** BZB ALL

User View

Grid View

|   |   |   |
|---|---|---|
| TV 1<br><input type="button" value="BZB"/>        | TV 2<br><input type="button" value="BLURAY"/>     | TV 3<br><input type="button" value="YOUTUBE"/>    |
| TV 4<br><input type="button" value="PS4"/>        | TV 5<br><input type="button" value="LANDSCAPES"/> | TV 6<br><input type="button" value="LANDSCAPES"/> |
| TV 7<br><input type="button" value="CHROMECAST"/> | TV 8<br><input type="button" value="LANDSCAPES"/> | TV 9<br><input type="button" value="LANDSCAPES"/> |

**Input Source**

## Video Output Interface

## B. Video Wall Interface

**BZBGear**  
Solutions to Amplify Your World™

Main

- Product Information
- Configuration
  - Mode
  - Matrix Switcher
  - Video Wall
  - Multiview
- Presets
- Status
- Inputs
- Outputs
- Settings
  - Input Settings
  - Output Settings

**Video Wall** W-3x3

Output Status

2X2 RD

| Outputs | Status      | Input      |
|---------|-------------|------------|
| TV 1    | Single      | BZB        |
| TV 2    | Single      | BLURAY     |
| TV 3    | Single      | YOUTUBE    |
| TV 4    | Single      | PS4        |
| TV 5    | VideoWall 1 | LANDSCAPES |
| TV 6    | VideoWall 1 | LANDSCAPES |
| TV 7    | Single      | CHROMECAST |
| TV 8    | VideoWall 1 | LANDSCAPES |
| TV 9    | VideoWall 1 | LANDSCAPES |

**Input Source**



### C. Preset Interface

Rename for each Preset scene, Save/ Call/ Clear preset.

#### Matrix Switcher

| Preset name |  | Apply Preset                             | Clear Preset |
|-------------|--|--|--------------|
| BZB ALL     |  | <input checked="" type="checkbox"/> Call |              |
| ALL BR      |  | <input checked="" type="checkbox"/> Call |              |
| ALL YT      |  | <input checked="" type="checkbox"/> Call |              |
| 3X3         |  | <input checked="" type="checkbox"/> Call |              |
| 1X3X3       |  | <input checked="" type="checkbox"/> Call |              |
| ALL ENGAGE  |  | <input checked="" type="checkbox"/> Call |              |
| 2 OF EACH   |  | <input checked="" type="checkbox"/> Call |              |
| 2P2         |  | <input checked="" type="checkbox"/> Call |              |

#### Video Wall

| Preset name    |  | Apply Preset                             | Clear Preset |
|----------------|--|--|--------------|
| 3x3 landscapes |  | <input checked="" type="checkbox"/> Call |              |
| 3x2 D          |  | <input checked="" type="checkbox"/> Call |              |
| 2x2 RU         |  | <input checked="" type="checkbox"/> Call |              |
| 2X2 RD         |  | <input checked="" type="checkbox"/> Call |              |
| 3X1 3X2        |  | <input checked="" type="checkbox"/> Call |              |
| 1X3L 2X2U      |  | <input checked="" type="checkbox"/> Call |              |
| 1X3X3          |  | <input checked="" type="checkbox"/> Call |              |
| SPLICING       |  | <input checked="" type="checkbox"/> Call |              |

#### Multiviewer

| Preset name    |  | Apply Preset                             | Clear Preset |
|----------------|--|--|--------------|
| 4 input 1      |  | <input checked="" type="checkbox"/> Call |              |
| 4 input 2      |  | <input checked="" type="checkbox"/> Call |              |
| 6 input 1      |  | <input checked="" type="checkbox"/> Call |              |
| 3x3            |  | <input checked="" type="checkbox"/> Call |              |
| 2 main below   |  | <input checked="" type="checkbox"/> Call |              |
| 6 input 2      |  | <input checked="" type="checkbox"/> Call |              |
| 6 input 3      |  | <input checked="" type="checkbox"/> Call |              |
| 1 main 7 small |  | <input checked="" type="checkbox"/> Call |              |

### Audio Interface

#### Output

| Output | Edit Name | Video                               | HDMI Audio                          | Audio Source                        | Audio Extraction                    | Extraction Source                     | Resolution                    | Rotation                            |
|--------|-----------|-------------------------------------|-------------------------------------|-------------------------------------|-------------------------------------|---------------------------------------|-------------------------------|-------------------------------------|
| Out 1  | TV 1      | <input checked="" type="checkbox"/> | <input checked="" type="checkbox"/> | Audio Foll <input type="checkbox"/> | <input checked="" type="checkbox"/> | Audio Follow <input type="checkbox"/> | 4K60 <input type="checkbox"/> | <input checked="" type="checkbox"/> |
| Out 2  | TV 2      | <input checked="" type="checkbox"/> | <input checked="" type="checkbox"/> | Audio Foll <input type="checkbox"/> | <input checked="" type="checkbox"/> | Audio Follow <input type="checkbox"/> | 4K60 <input type="checkbox"/> | <input checked="" type="checkbox"/> |
| Out 3  | TV 3      | <input checked="" type="checkbox"/> | <input checked="" type="checkbox"/> | Audio Foll <input type="checkbox"/> | <input checked="" type="checkbox"/> | Audio Follow <input type="checkbox"/> | 4K60 <input type="checkbox"/> | <input checked="" type="checkbox"/> |
| Out 4  | TV 4      | <input checked="" type="checkbox"/> | <input checked="" type="checkbox"/> | Audio Foll <input type="checkbox"/> | <input checked="" type="checkbox"/> | Audio Follow <input type="checkbox"/> | 4K60 <input type="checkbox"/> | <input checked="" type="checkbox"/> |
| Out 5  | TV 5      | <input checked="" type="checkbox"/> | <input checked="" type="checkbox"/> | Audio Foll <input type="checkbox"/> | <input checked="" type="checkbox"/> | Audio Follow <input type="checkbox"/> | 4K60 <input type="checkbox"/> | <input checked="" type="checkbox"/> |
| Out 6  | TV 6      | <input checked="" type="checkbox"/> | <input checked="" type="checkbox"/> | Audio Foll <input type="checkbox"/> | <input checked="" type="checkbox"/> | Audio Follow <input type="checkbox"/> | 4K60 <input type="checkbox"/> | <input checked="" type="checkbox"/> |
| Out 7  | TV 7      | <input checked="" type="checkbox"/> | <input checked="" type="checkbox"/> | Audio Foll <input type="checkbox"/> | <input checked="" type="checkbox"/> | Audio Follow <input type="checkbox"/> | 4K60 <input type="checkbox"/> | <input checked="" type="checkbox"/> |
| Out 8  | TV 8      | <input checked="" type="checkbox"/> | <input checked="" type="checkbox"/> | Audio Foll <input type="checkbox"/> | <input checked="" type="checkbox"/> | Audio Follow <input type="checkbox"/> | 4K60 <input type="checkbox"/> | <input checked="" type="checkbox"/> |
| Out 9  | TV 9      | <input checked="" type="checkbox"/> | <input checked="" type="checkbox"/> | Audio Foll <input type="checkbox"/> | <input checked="" type="checkbox"/> | Audio Follow <input type="checkbox"/> | 4K60 <input type="checkbox"/> | <input checked="" type="checkbox"/> |
| All    |           | <input checked="" type="checkbox"/> | <input checked="" type="checkbox"/> | Audio Foll <input type="checkbox"/> | <input checked="" type="checkbox"/> | Audio Follow <input type="checkbox"/> | 4K60 <input type="checkbox"/> | <input checked="" type="checkbox"/> |



## EDID Interface

### Input

| Input | Edit Name                               | Video                               | Copy EDID From                                 |
|-------|---|-------------------------------------|--|
| In 1  | <input type="text" value="BZB"/>        | <input checked="" type="checkbox"/> | Default 1:4096x2160P@60-444 HDR:None LPCM:2. ▾ |
| In 2  | <input type="text" value="BLURAY"/>     | <input checked="" type="checkbox"/> | Default 1:4096x2160P@60-444 HDR:None LPCM:2. ▾ |
| In 3  | <input type="text" value="YOUTUBE"/>    | <input checked="" type="checkbox"/> | Default 1:4096x2160P@60-444 HDR:None LPCM:2. ▾ |
| In 4  | <input type="text" value="PS4"/>        | <input checked="" type="checkbox"/> | Default 1:4096x2160P@60-444 HDR:None LPCM:2. ▾ |
| In 5  | <input type="text" value="LANDSCAPES"/> | <input checked="" type="checkbox"/> | Default 1:4096x2160P@60-444 HDR:None LPCM:2. ▾ |
| In 6  | <input type="text" value="CHROMECAST"/> | <input checked="" type="checkbox"/> | Default 1:4096x2160P@60-444 HDR:None LPCM:2. ▾ |
| In 7  | <input type="text" value="ENGAGE"/>     | <input checked="" type="checkbox"/> | Default 1:4096x2160P@60-444 HDR:None LPCM:2. ▾ |
| In 8  | <input type="text" value="XBOX"/>       | <input checked="" type="checkbox"/> | Default 1:4096x2160P@60-444 HDR:None LPCM:2. ▾ |
| In 9  | <input type="text" value="4K MEDIA"/>   | <input checked="" type="checkbox"/> | Default 1:4096x2160P@60-444 HDR:None LPCM:2. ▾ |
| All   |   | <input checked="" type="checkbox"/> | Default 1:4096x2160P@60-444 HDR:None LPCM:2. ▾ |

Copy EDID From  to

Select Custom EDID File  to

## SYSTEM Interface

Include: **Network, Reset, Password.**

### Network Interface Settings

#### Setting and Displaying IP Information:

1. **MAC Address:**
  - The MAC address is for display only and cannot be modified.
2. **Static IP Address:**
  - When DHCP is turned off, you can modify the static IP address.
  - Changes take effect after applying the new settings.
  - The web interface will automatically require a login again after an 8-second countdown.
3. **Dynamic IP Address:**
  - When DHCP is turned on, the IP address field becomes unmodifiable (grayed out).
  - Only the current IP address will be displayed.

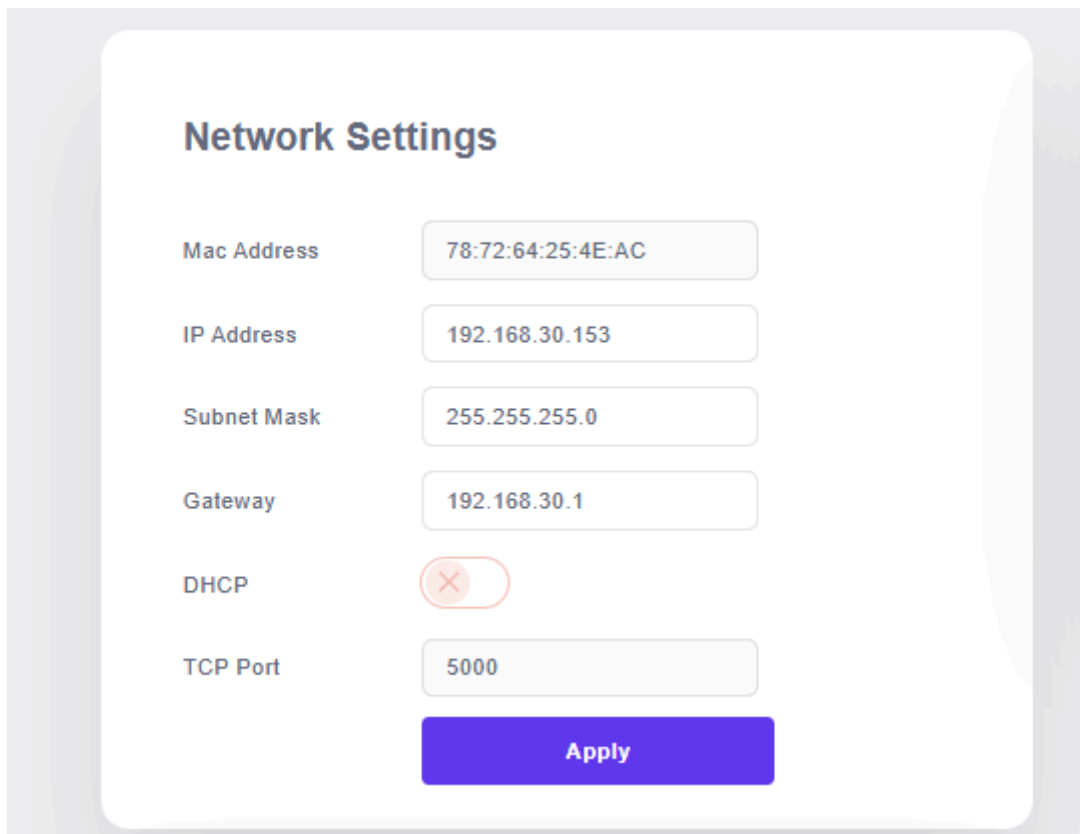

The screenshot shows a 'Network Settings' window with the following fields and values:

| Field       | Value                    |
|-------------|--------------------------|
| Mac Address | 78:72:64:25:4E:AC        |
| IP Address  | 192.168.30.153           |
| Subnet Mask | 255.255.255.0            |
| Gateway     | 192.168.30.1             |
| DHCP        | <input type="checkbox"/> |
| TCP Port    | 5000                     |

At the bottom of the settings window is a blue 'Apply' button.

Reset Interface

## Device Control Options

### Reboot:

- **Operation:** Reboots the device.

### Factory Run:

- **Operation:** Restores running data, including settings for video, audio, EDID, and setup (preset settings are retained).

### Factory User:

- **Operation:** Restores all settings to factory defaults.

### Standby:

- **Operation:** Click to enter standby mode. Click again to wake up the device.

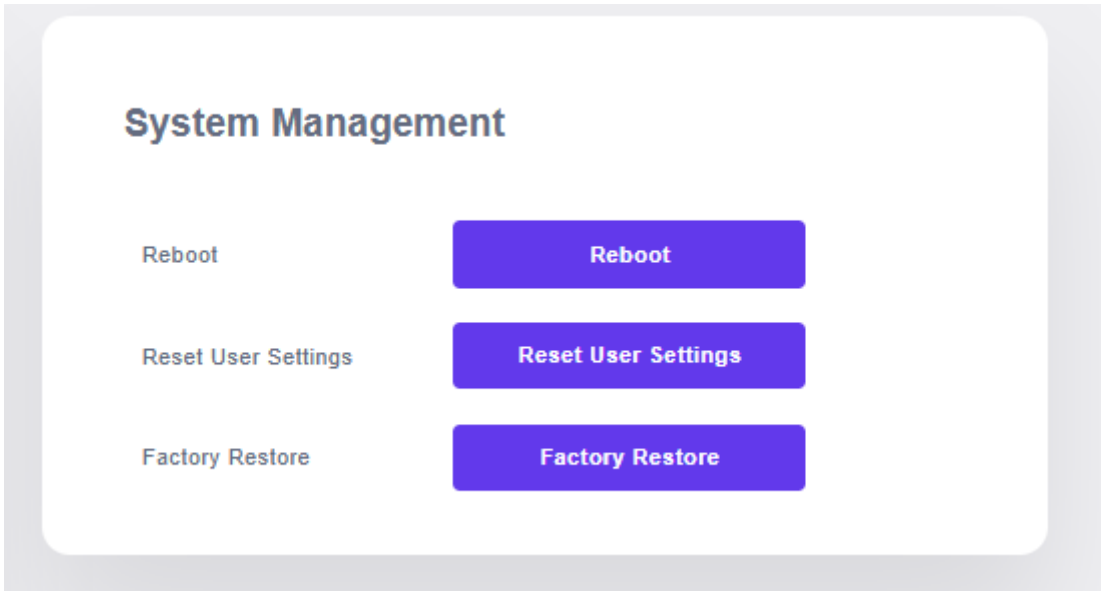

### Password Interface

Modify password for current login account Default Account: admin  
Default Password: admin  
(Only support 5~15 bits, support alphabets/numbers/underline)

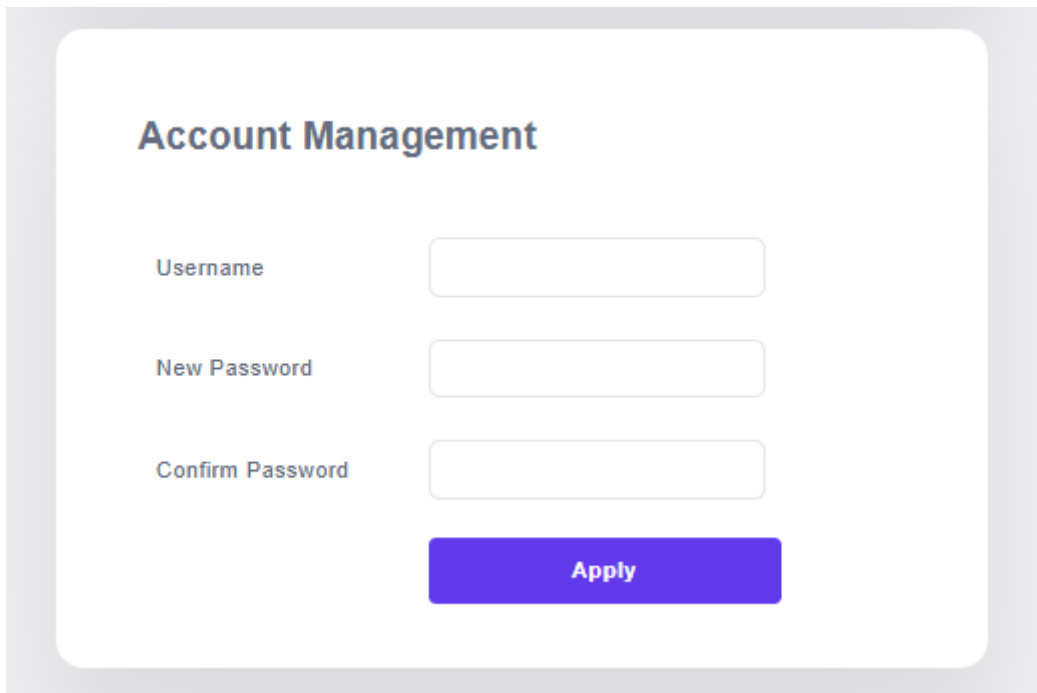



## RS-232 Control

Operations may vary depending on the control program used to send RS-232 commands.

Select the serial port that the unit is connected to on the PC using a serial cable.

- Baud rate: 115200 (default)
- Data bit: 8
- Stop bit: 1
- Check bit: none

Input commands in the command input area to control the local or remote receivers.

Instructions:

1. All commands start with “#”
  - a. “%c” command head
  - b. “d” parameters
  - c. “|” lock
2. The “\_” in the commands cannot be omitted.
  - a. Parameter: %d: 0 means ALL
  - b. 1-x means specified output(1~9)
3. Command head & Parameter1 & Parameter2... need to have one “SPACE” between them.

The following table is only an example. Please refer to the list of instructions.

| Instruction description | instruction | parameter 1 | parameter 2 | parameter 3 |
|-------------------------|-------------|-------------|-------------|-------------|
| Video switch            | #video_%c   | out%d       | in%d        | matrix=%d   |
| Audio Mode Switch       | #audio_%c   | in%d        | /           | enc=%d      |
| EDID                    | #EDID_%c    | In%d        | cfg=%d      | /           |

**Please refer to the "Command list" for details.**

Example: video wall input switch to input3, video wall mode 3x2, cascade layer 2.

Operation format: #splice input=3 h=2 v=3 c=2



## IR System

The matrix can pass the IR signal through the IR system to the HDMI source or pass the IR signal from the HDMI source to the HDMI sink.



### Dual way IR using:

- Step 1: "IR IN" is for UTP output, "IR OUT" is for input channel
- Step 2: "IR IN ALL" Controls all input IR; "IR OUT ALL" Controls all output IR.
- Step 3: Receivers support connection with IR receiver to control the Matrix via remote.
- Step 4: Matrix IR channel "IR IN" supports connection with IR-RX cable to control the Matrix.

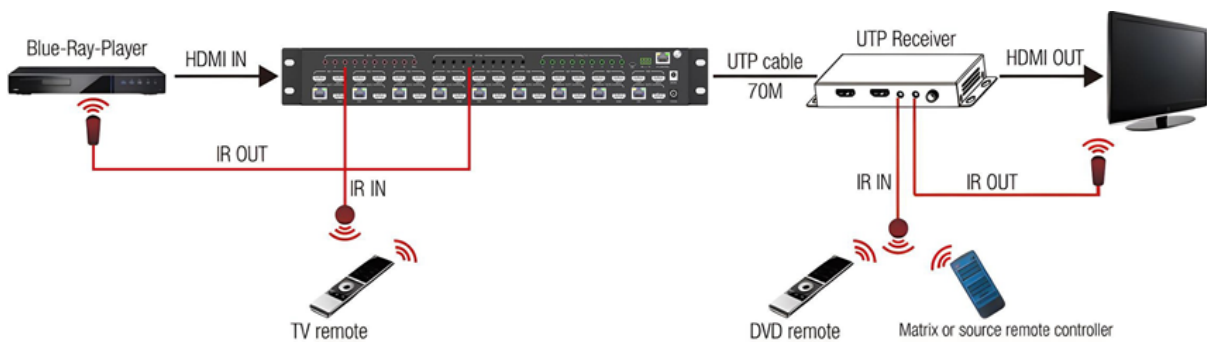



# Application Diagram

## 1. Seamless switch 9x9 HDMI Matrix

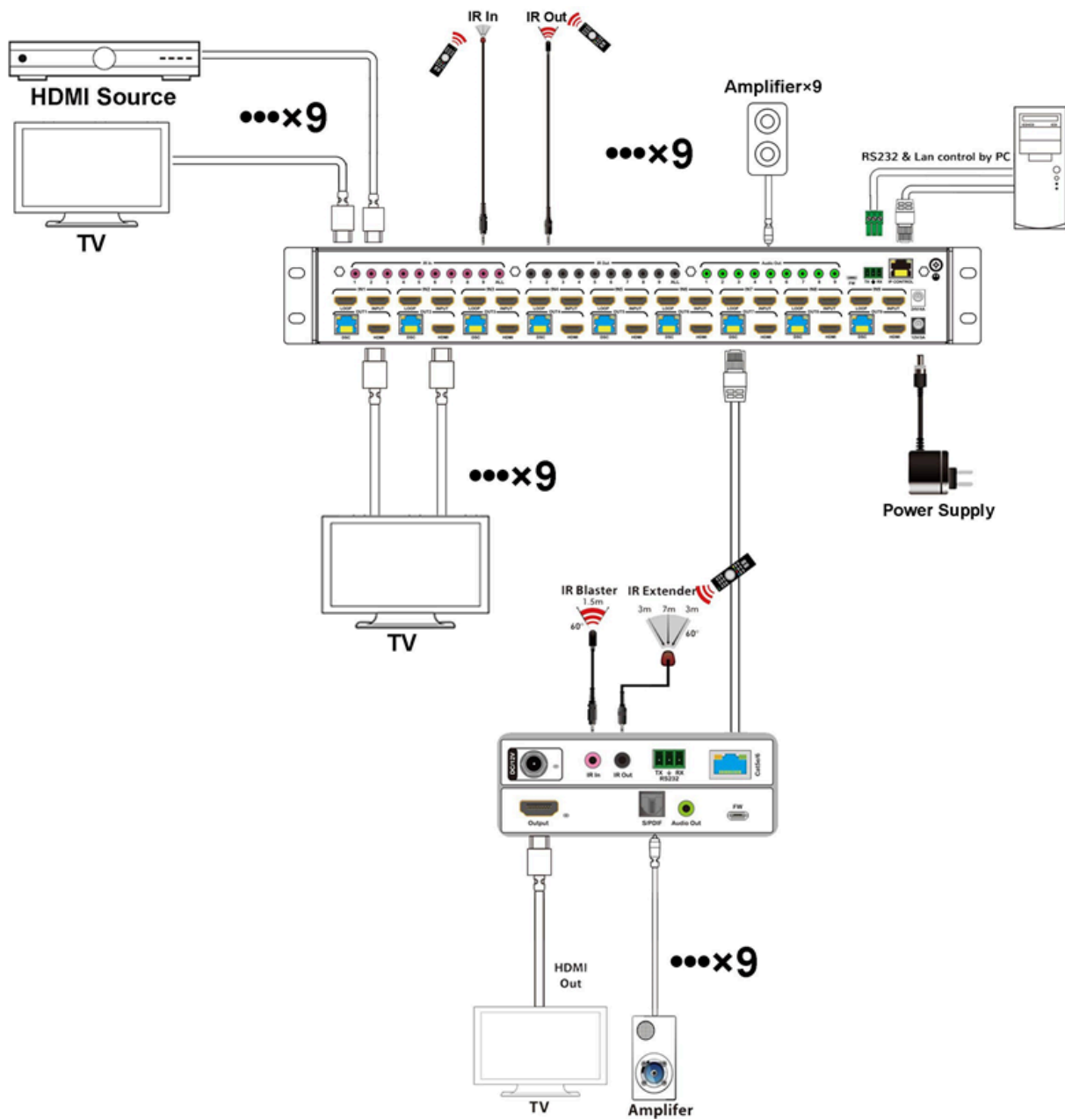



## 2. Diagram of 3x3 Video Wall Displaying

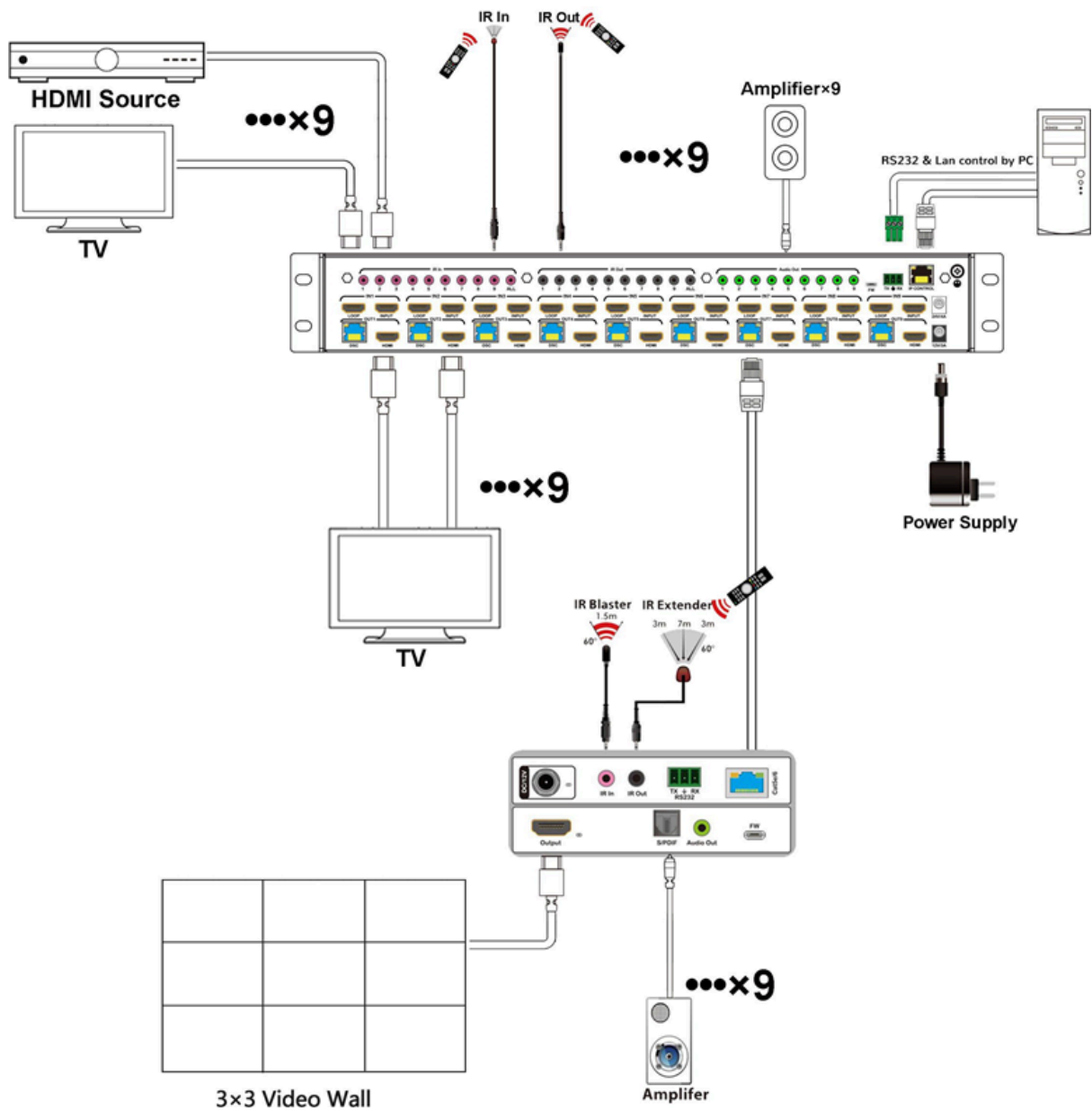



# BZBGear Switch Control App

## BG-Switch-Control | Quick User Guide



**BZBGear** Switch Control App

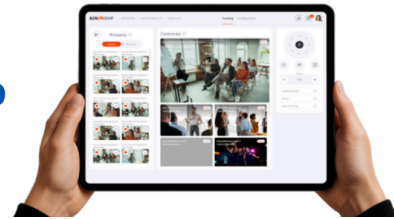

### Overview

The **BZBGear Switch Control App (BG-Switch-Control)** is a multi-platform network control application for compatible BZBGear matrix switchers. It provides centralized control of **video routing, audio routing, presets, and video wall configurations** through an intuitive graphical interface.

### Platform Compatibility

Supported operating systems:

- **Windows**
- **macOS**
- **iOS**
- **Android**
- All control devices must be connected to the **same local network** as the matrix switcher.

### Connection & Startup

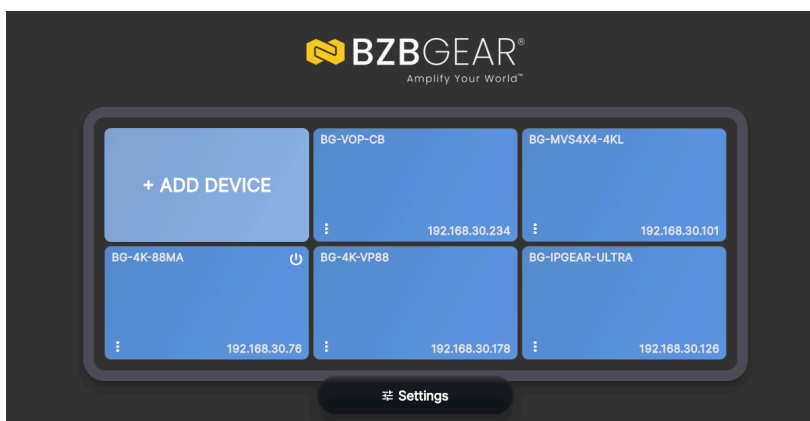

1. Connect the BZBGear matrix switcher to the local network.
2. Connect the control device (PC, tablet, or smartphone) to the same network.
3. Launch the **BG-Switch-Control App**.



4. Select the correct product from the (Add Device) drop-down list
5. Fill in the device information (IP address, name, etc.)

### Matrix Switching



- Rename input and output sources (Optional)
- Press and hold an input source.
- Drag the input from the **Inputs panel** to the desired output.
- Release to complete the assignment.
- A single input can be routed to **multiple outputs simultaneously**.

### Preset Management

Presets allow quick saving and recall of system configurations.

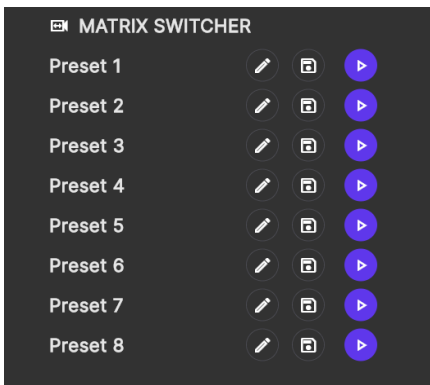

1. Configure routing or video wall settings.
2. Select **Save as Preset**.
3. Assign a preset number and name.
4. Recall presets at any time to instantly restore configurations.



## Video Wall Control

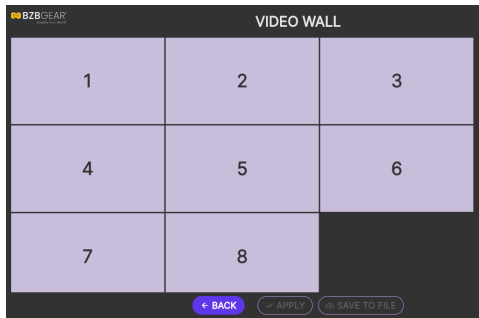

- Select **Create Video Wall**.
- Drag and arrange outputs into the desired layout.
- Select a source to span across the video wall.
- Select **Set Video Wall** to apply.
  - Video walls appear on the main screen and support **real-time switching** and **preset storage**.

## Pass-Through Mode

Pass-Through mode restores a direct, default input-to-output mapping.

This mode is useful for:

- System resets
- Testing
- Simplified routing

## Refresh Data

The **Refresh Data** function resynchronizes the app with the connected switcher.

Use this if configuration changes are made or if the interface appears out of sync.

## App Capabilities

- Matrix video routing
- Video wall creation and control
- Preset save and recall
- Audio matrix control (*supported devices*)
- Multi-user access with role-based permissions
- Multi-platform operation



## Tech Support

---

Have technical questions? We may have answered them already!

Please visit BZBGear's support page ([bzbgear.com/support](https://bzbgear.com/support)) for helpful information and tips regarding our products. Here you will find our Knowledge Base ([bzbgear.com/knowledge-base](https://bzbgear.com/knowledge-base)) with detailed tutorials, quick start guides, and step-by-step troubleshooting instructions. Or explore our YouTube channel, BZB TV ([youtube.com/c/BZBTVchannel](https://youtube.com/c/BZBTVchannel)), for help setting up, configuring, and other helpful how-to videos about our gear.

Need more in-depth support? Connect with one of our technical specialists directly:

| <b>Phone</b>   | <b>Email</b>   | <b>Live Chat</b>                              |
|----------------|--|---|
| 1.888.499.9906 | <a href="mailto:support@bzbgear.com">support@bzbgear.com</a> | <a href="https://bzbgear.com">bzbgear.com</a> |

## Limited Product Warranty Terms

---

Pro Line: 5-year warranty from the date of purchase for AV/Broadcasting products bought on or after August 1, 2024.

Essential Line: 3-year warranty from the date of purchase for AV/Broadcasting products bought on or after August 1, 2024.

Cables: Lifetime Limited Product Warranty.

For complete warranty information, please visit [bzbgear.com/warranty](https://bzbgear.com/warranty).

For questions, please call 1.888.499.9906 or email [support@bzbgear.com](mailto:support@bzbgear.com).

## Mission Statement

---

BZBGear is a breakthrough manufacturer of high-quality, innovative audiovisual equipment ranging from AVoIP, professional broadcasting, conferencing, home theater, to live streaming solutions. We pride ourselves on unparalleled customer support and services. Our team offers system design consultation, and highly reviewed technical support for all the products in our catalog. BZBGear delivers quality products designed with users in mind.

## Copyright

---

All the contents in this manual and its copyright are owned by BZBGear. No one is allowed to imitate, copy, or translate this manual without BZBGear's permission. This manual contains no guarantee, standpoint expression or other implies in any form. Product specification and information in this manual is for reference only and subject to change without notice.

**All rights reserved.** No reproducing is allowed without acknowledgement.