

BG-Commander-Jr

**Universal Compact Serial and IP PTZ Camera Joystick Controller
with RS-232/422 Support**

User Manual







TABLE OF CONTENTS

Statement	4
Safety Precaution	4
Introduction	5
Features	5
Packing List	5
Specifications	6
Operation Controls and Functions	7
How to Set More Than 5 Presets on the BG-Commander-Jr	11
Interface Function and Connection Diagram	12
RS422/RS485 Interface Connection	12
RS232 Interface Connection	13
LAN Interface Connection	13
System Menu Operation Instructions	14
SYSTEM MENU	14
SYSTEM SETTING	14
COMM SETTING	15
ETHERNET SETTING	15
PASSWORD SETTING	16
System Menu Guide	16
Web GUI	17
Tech Support	19
Limited Product Warranty Terms	19
Mission Statement	20
Copyright	20



Statement

Please read these instructions carefully before connecting, operating, or configuring this product. Please save this manual for future reference.

Safety Precaution

- To prevent damaging this product, avoid heavy pressure, strong vibration, or immersion during transportation, storage, and installation.
- The housing of this product is made of organic materials. Do not expose to any liquid, gas, or solids which may corrode the shell.
- Do not expose the product to rain or moisture.
- To prevent the risk of electric shock, do not open the case. Installation and maintenance should only be carried out by qualified technicians.
- Do not use the product beyond the specified temperature, humidity, or power supply specifications.
- This product does not contain parts that can be maintained or repaired by users. Damage caused by dismantling the product without authorization from BZBGear is not covered under the warranty policy.
- Installation and use of this product must strictly comply with local electrical safety standards.



Introduction

The BG-Commander-Jr is a compact professional-grade joystick controller. The 2-axis joystick and zoom bridge key design provides refined control, durability, and stability. The responsive silicone buttons are backlit for a comfortable user experience in low light environments.

The BG-Commander-Jr is designed for simultaneous communication and system compatibility with its integrated VISCA, UDP, and PELCO P/D control protocols in addition to RS232, RS422/RS485, and IP(UDP) interfaces.

This compact and versatile controller is ideal for an array of applications ranging from professional AV systems, broadcasting, education, telemedicine, to video conferencing, houses of worship, and more.

Features

- Intuitive compact design.
- 4 color LED multi-screen display.
- Separated Pan/Tilt joystick and zoom keys for better control and reliability.
- 7-level PTZ speed control with visual indicator.
- One-button click for auto, manual, and OPT focus modes.
- Wide compatibility allows for control of most PTZ cameras.
- Password settings available
- Shows preset set, call, & reset in real-time on the main display screen.

Packing List

- BG-Commander-Jr
- Power Adapter
- 4-pin Phoenix Connector
- User Manual



Specifications

Communication and Control Interface	
RS422/RS485 Interface	Phoenix Contact 4 pin 3.81mm Terminal
RS232C Interface	DB9 Male Interface
LAN Interface	RJ45 Female Interface
Power Supply	JEITA Type 4 Female Interface
Upgrade Online	Micro USB Female Interface
Camera Control and Operation	
Supported number of cameras	5
Communication Protocol	VISCA, PELCO P/D, UDP
Number of LED Displays	4 Units Color LED Display Screen
Number of Camera Channels	5
Variable knobs	4
Joystick	2-Axis
Zoom Mode	Tele-Wide Bridge Keys
Buttons	17 Silicon Button
Presets Short keys	5 Presets per Each channel
Focus Mode	Auto/ Manual/ OPT
Pan/Tilt Rotation Speed	7-Level Adjustment
Zoom In/Out Speed	7-Level Adjustment
AE Mode	The mode can be switched arbitrarily, and the value can be adjusted
WB Mode	
Camera Menu	One-keys for call
Control Signal Format	
Baud Rate	2400bps, 4800bps, 9600bps, 19200bps, 38400bps
Date Bits	8 Bit
Stop Bit	1 Bit
Parity bit	NONE
Internet Protocol	UDP / VISCA OVER IP
Power Supply and Consumption	
Rated Voltage	DC 12V
Rated Current	0.3A max
Max Power Consumption	3.6W



Physical and Misc.	
Password Privacy Protection	YES
Kingston's Lock Holes	YES
Working Temperature	0°C ~ 40°C (32 °F ~ 104 °F)
Storage Temperature	-20°C ~ +60°C (-4 °F ~ 140 °F)
Working Environment	Indoor
Dimensions (L x W x H)	244 x 164 x 48mm
Gross Weight	1.1 kg

Operation Controls and Functions

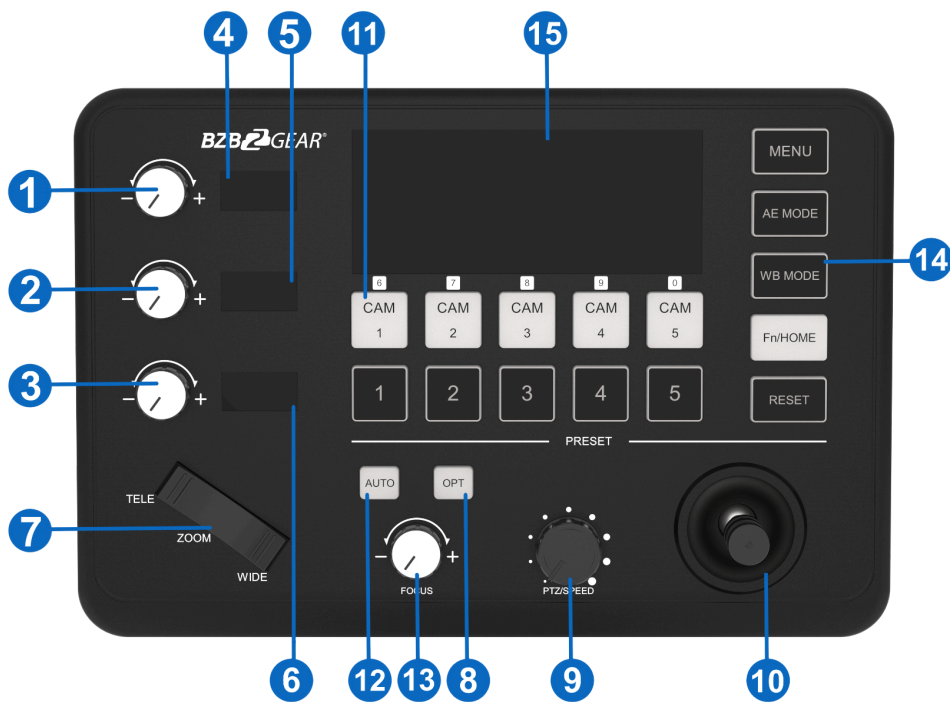

1. Knob 1 adjusts the camera exposure parameter or red gain value depending on mode selected (see below). Turning the knob to the right increases the red gain value, while turning left decreases the red gain value.
2. Knob 2 adjusts the camera exposure parameter or blue gain value depending on mode selected (see below). Turning the knob to the right increases the blue gain value, while turning left decreases the blue gain value.



3. Knob 3 adjusts the camera exposure parameter. Turning the knob to the right increases the camera exposure, while turning left decreases the camera exposure.
4. **LED Display:** Displays the values adjusted by knob 1.
5. **LED Display:** Displays the values adjusted by knob 2.
6. **LED Display:** Displays the values adjusted by knob 3.
7. **Zoom Bridge Key:** Controls the camera's zoom in/out. For example, press the 'TELE' end of the bridge key to zoom in, and press 'WIDE' to zoom out. The zoom speed is pressure sensitive. The harder the key is pressed, the faster the camera zooms.

8. Focus Functions

The [AUTO] button can be pressed to change the focus mode from manual to automatic or vice versa. When the backlight of the [AUTO] button is lit, the camera is in autofocus mode. When the backlight of the [AUTO] button is off, the camera is in manual focus mode.

The [OPT] key is used to trigger the camera's single focus mode. The camera will enter one-shot autofocus mode at the same time.

9. PTZ Speed Adjustment Knob

This knob is used to adjust the speed of camera Pan, Tilt and Zoom, with a total of 7 levels. The current level will be shown on the Led display. When the value is smaller the pan/tilt rotation speed or the zoom speed of the camera controlled by the keyboard will be slower.

10.2-Axis Joystick

The joystick controls camera Up, Down, Left, and Right movement. When the camera or keyboard menu is opened, the joystick is used to control the menu cursor Up, Down, Left, and Right movement and modify parameters.

11. Camera Select Buttons

[CAM1] to [CAM5] are shortcut keys for camera selection. When you select any camera, the backlight of the corresponding button will light up green. All of the parameters and settings of the keyboard will be changed to the current selected camera.

Note: The communication parameters (address ID, protocol, baud rate, IP address, port number, etc.) of each channel can be set individually. The controller supports mixed use of multiple protocols through different channels/camera selections.



12. Presets Function Zone

- **[Number Keys]**

SETTING PRESETS:

Long Press and hold the number key for 2 seconds (such as [Number key 1], when the screen displays "Set Preset 1" it means that preset 1 has been saved)

CALL PRESETS:

Short press the preset number to call Presets, (for example, [Number key 1], when you press the [Number key 1] the screen displays "Show Preset 1", which means that preset 1 has been called).

- **[RESET Key]**

TO BE CLEAR THE PRESET SETTING

Press [RESET key]+[Number key] to clear the preset position setting.

After pressing the [RESET key], the green backlight starts to flash, press the preset number that needs to be cleared. For example, [RESET]+ [Number key 1], the green backlight of the [RESET key] stops flashing, and at the same time, "Reset Preset 1" is displayed on the screen, which means that preset 1 has been cleared.

13. FOCUS Knob

This knob is used to adjust the camera's focal length. Rotating to the right will adjust the camera focus length to the near field. Rotating to the left will adjust the camera focus length to the far field. To use this function, the keyboard's focus mode needs to be changed to Manual by pressing the [AUTO] button (no backlight) and is unavailable in AUTO mode (backlight illuminated green).

14. Function Key Zone

- **[Menu Key]**

Turn ON/OFF the camera menu by long pressing the [MENU] button for 3 seconds and the display will show the system menu.

- **[AE MODE Key]**

The [AE Mode] key is used to change the automatic exposure mode of the camera. Each time it is pressed, the camera changes to a different exposure mode.

Depending on exposure mode, the corresponding functions of Knob 1, Knob 2 and Knob 3 are different. It is shown in real time on the display to the right of the knob.



The specific functions of the knobs are shown in Table 1 below:

Exposure Mode	Knob 1	Knob 2	Knob 3
Auto	NOT USED	NOT USED	Exposure Compensation
Manual	Shutter	Iris	Gain
Shutter Priority	Shutter	NOT USED	Exposure Compensation
Iris Priority	Iris	NOT USED	Exposure Compensation
Brightness Priority	Iris	Gain	Exposure Compensation

Table 1

- **[WB MODE Key]**

The [WB MODE] button is used to change the white balance of the camera. Each time it is pressed, the camera will be changed to a different white balance mode. Depending on the white balance mode selected, the corresponding functions of Knob 1, Knob 2 are different.

The specific functions of the knobs are shown in Table 2 below:

White Balance Mode	Knob 1	Knob 2
Auto	NOT USED	NOT USED
Manual	Red Gain	Blue Gain

Table 2

- **[Fn/HOME Key]**

The [Fn/HOME] button is reserved for adding custom functions. The factory default state is: short press the key to enter the sub-menu of the camera, long pressing the key for 3 seconds will cause the selected camera to return to its Home Position.

15. LED DISPLAY

It is used to display the current status & settings of the keyboard in real time including IP address, Port number, serial port address, communication protocol, Baud Rate and other information in the keyboard menu. The brightness of the display can be set through the keyboard menu.



How to Set More Than 5 Presets on the BG-Commander-Jr

This guide will help you set up to 10 presets on your BG-Commander-Jr. If you've already configured the initial 5 presets and need to add more, follow these steps. If you encounter any difficulties, feel free to reach out to BZBGear Support for assistance.

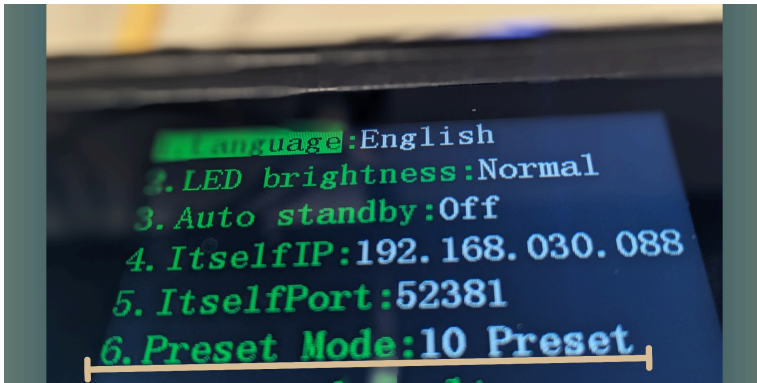

1. Adjusting Preset Mode

Begin by accessing the settings menu. Press and hold the [Menu] button until the menu options appear. Navigate to the System Settings menu and switch the preset mode from 5 to 10. This expands your preset options for greater flexibility.



2. Setting Presets 6-10

Once the preset mode has been updated successfully, you can proceed to add additional presets. Press the Reset button located above the joystick. When all buttons illuminate green, use the top row of buttons labeled 6-0 (0 representing #10) from left to right to set the new presets. Press and hold the desired button until you see the message "Set preset [#]" appear on the LCD screen. Confirm that you've selected the correct preset number.

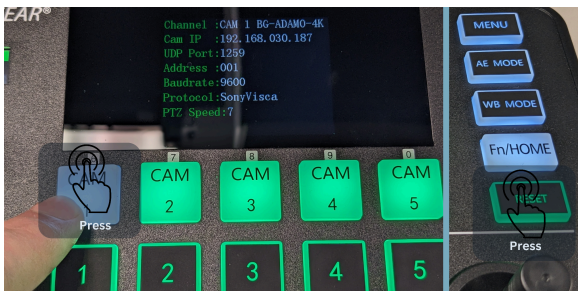



3. Recalling Presets 6-10

To recall presets 6-10, press the Reset button again to illuminate all buttons green. Instead of holding down the preset number, simply press the button corresponding to the desired preset as you would for the initial 5 presets.

Interface Function and Connection Diagram

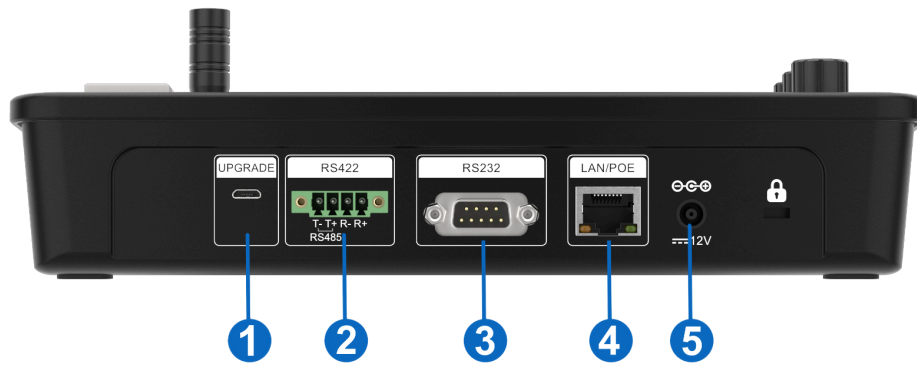

No.	Name	Function Description
1	Upgrade Interface	Use a Micro USB cable connected to a computer to upgrade the hardware of the keyboard.
2	RS422/RS485 Interface	Connect and control a camera through RS422 or RS485 for control.
3	RS232 Interface	Connect and control a camera through RS232.
4	LAN/POE Interface	The LAN Interface is used for connection to a network switch to connect to a networked PTZ Camera.
5	DC Power Supply Interface	Connect to provided power supply.

RS422/RS485 Interface Connection





RS232 Interface Connection



LAN Interface Connection





System Menu Operation Instructions

System Menu Operation & Explanation

1. Long Press [MENU] for 3 seconds which will open the system Menu.
2. Use the joystick to navigate the system menu by moving up and down or to change the parameters of the current menu item.
3. Move right on the joystick to enter the currently selected menu item or to save and exit the current menu item.
4. Move left on the joystick to exit the current menu item and disregard changes.
5. Press [MENU] to exit the system menu.
6. Press the number keys [0]~[9] to input a numerical value such as an IP Address or Port number.
7. The green backlight of [CAM1]~[CAM5] will illuminate when the corresponding value of numbers on the silk screen above are 6~0.

SYSTEM MENU

1. Long press the [MENU] button for 3 seconds to open the system menu.
2. Use the joystick to control the menu cursor and move it up and down.

1. System Setting
2. COMM Setting
3. Ethernet Setting
4. Password Setting

SYSTEM SETTING

Move the Cursor to [System Setting], then press right on the joystick to enter the 'System Setting' menu:

1. Language: English
2. LED Display Brightness: Normal
3. Automatically Standby: Off
4. Itself IP: 192.168.001.088
5. Itself Port: 52381
6. Factory default Setting
7. About Keyboard

- **[Language]**
Move the joystick up/down to change the language and then press right to save the setting.
Language Options: English or Chinese.
- **[LED Display Brightness]**
Change the brightness of the LED display: Low, Normal, High.
- **[Automatically Standby]**
Set the keyboard to automatically enter standby mode without any operation within a limited time. Selectable: Off, 1 minute, 2 minutes, 5 minutes, 10 minutes, 20 minutes, 30 minutes, 60 minutes.



- **[Itself IP]**
Controller will auto-assign itself an IP Address / Port Number. The default IP is 192.168.1.88, default Port 52381.
- **[Factory default Setting]**
Restore factory default settings.
- **[About Keyboard]**
Review information of the controller including: model, firmware version, S/N and other information.

COMM SETTING

Move the cursor to [Comm Setting], then press right to enter Comm Setting:

1. Channel: CAM1 2. Address: 1 3. Baud Rate: 9600 4. Protocol: VISCA

- **[Channel]**
The available channels are CAM 1~5 which correspond to the buttons [CAM1]~[CAM5].
- **[Address]**
Set the serial communication address of the selected camera channel. If the current communication protocol is VISCA, the communication address can be from 1~7. If the current communication protocol is PELCO-D or PELCO-P, the address can be from 1~255.
- **[Baud Rate]**
Set the serial communication Baud Rate: 2400, 4800, 9600, 19200, 38400 bps.
- **[Protocol]**
Set the serial communication protocol of the selected channel (RS232, RS422/485, and IP). Available in: VISCA, PELCO P/D, UDP.

ETHERNET SETTING

Move the cursor to [Ethernet Setting], then move right to enter Ethernet Setting:

1. Channel: CAM1 2. Cam IP: 192.168.005.163 3. Port: 01259 4. IP Camera Search

- **[Channel]**
The available channels CAM 1~5 correspond to the buttons [CAM1]~[CAM5].



- **[Cam IP]**
Set the Cam IP of the selected channel, which can be directly input through the number keys. The cursor will automatically jump to the next entry after 3 numbers are entered in a section, otherwise press right on the joystick.
- **[Port]**
Set the UDP Port of the selected channel.
- **[IP Camera Search]**
Automatically searches for IP cameras on the network.

PASSWORD SETTING

Move the cursor to [Password Setting], then move right to enter Password:

1. Using Password : Enabled
2. Modify Password

- **[Using Password]**
How to use the password function : Change the password setting to ‘Enable.’ When enabled, a password is required to enter the menu. The default password is: 8888
- **[Modify Password]**
Users can change the password but please note if the password is changed, lost, or forgotten support may be limited from the manufacturer.

System Menu Guide

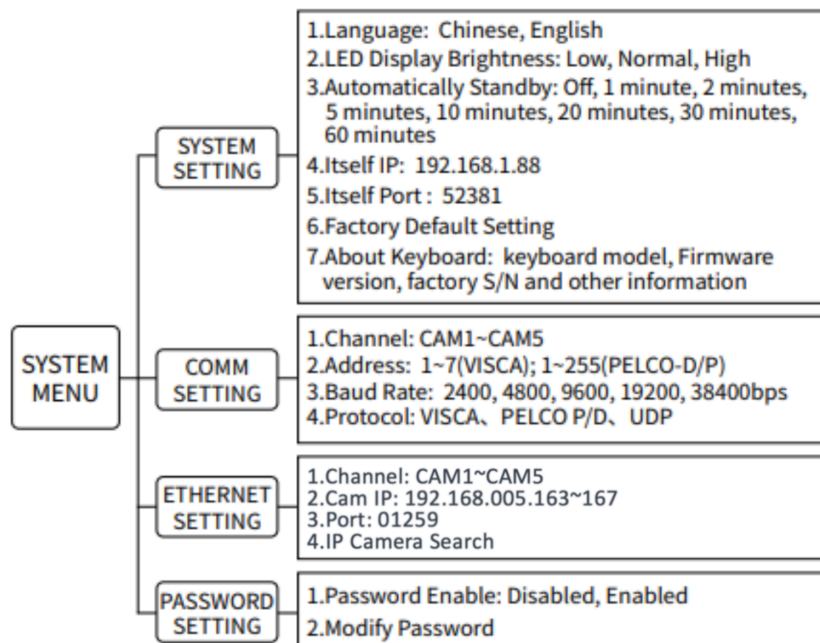



Web GUI

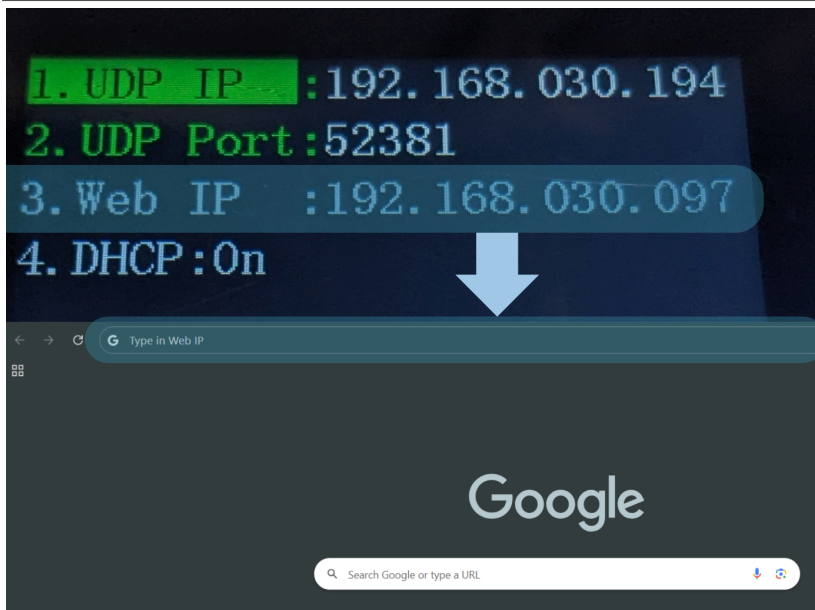

- Access the ItsselfIP settings in the menu
- Ensure the Web IP is on the same network as your device
- Enter the Web IP in the address bar of a browser and search
- Log in to the Web GUI
 - Username: admin
 - Password: admin

• System

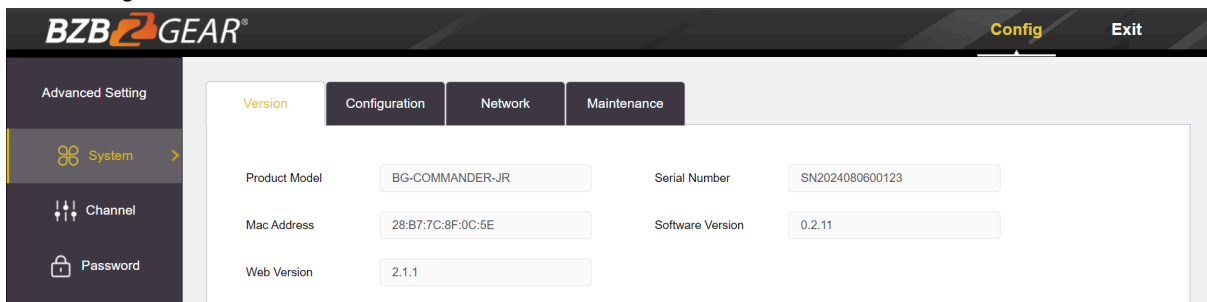

- **Version:** This section provides detailed product information.
- **Configuration:** Customize your system's settings here, including language options, LED brightness, and the number of available presets (choose between 5 and 10).
- **Network:** Configure network settings and manage the VISCA port on this page.
- **Maintenance:** Access options to reboot the system, perform a factory reset, import and export configurations, and upgrade the system.

• Channel

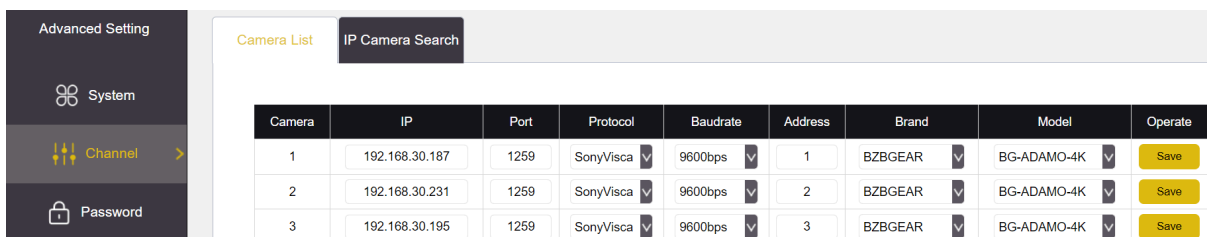

- **Camera List:** This page displays the current list of added cameras and available camera slots. You can edit camera inputs and manually add new cameras.



- **IP Camera Search:** Use this section to search the network for available cameras and add them to your camera list.

- **Password**

No	User Name	Local Right	Remote Right
1	admin	-1	-1

- This section allows you to enable and modify the password settings.



Tech Support

Have technical questions? We may have answered them already!

Please visit BZBGear's support page (bzbgear.com/support) for helpful information and tips regarding our products. Here you will find our Knowledge Base (bzbgear.com/knowledge-base) with detailed tutorials, quick start guides, and step-by-step troubleshooting instructions. Or explore our YouTube channel, BZB TV (youtube.com/c/BZBTVchannel), for help setting up, configuring, and other helpful how-to videos about our gear.

Need more in-depth support? Connect with one of our technical specialists directly:

Phone

1.888.499.9906

Email

support@bzbgear.com

Live Chat

bzbgear.com

Limited Product Warranty Terms

Pro Line: 5-year warranty from the date of purchase for AV/Broadcasting products bought on or after August 1, 2024.

Essential Line: 3-year warranty from the date of purchase for AV/Broadcasting products bought on or after August 1, 2024.

Cables: Lifetime Limited Product Warranty.

For complete warranty information, please visit bzbgear.com/warranty.

For questions, please call 1.888.499.9906 or email support@bzbgear.com.



Mission Statement

BZBGear is a breakthrough manufacturer of high-quality, innovative audiovisual equipment ranging from AVoIP, professional broadcasting, conferencing, home theater, to live streaming solutions. We pride ourselves on unparalleled customer support and services. Our team offers system design consultation, and highly reviewed technical support for all the products in our catalog. BZBGear delivers quality products designed with users in mind.

Copyright

All the contents in this manual and its copyright are owned by BZBGear. No one is allowed to imitate, copy, or translate this manual without BZBGear's permission. This manual contains no guarantee, standpoint expression or other implies in any form. Product specification and information in this manual is for reference only and subject to change without notice.

All rights reserved. No reproducing is allowed without acknowledgement.