

BG-COMMANDER-G2

**Universal Advanced Serial and IP PTZ Joystick Controller with 5"
Touch LCD Screen and POE/RS-232/422/485**

User Manual







TABLE OF CONTENTS

Statement	4
Safety Precaution	4
Introduction	5
Features	5
Packing List	6
Specifications	7
Operation Controls and Functions	8
Button and Knob Functions	9
Connection Diagrams	10
Serial Connection Guide	10
Web GUI	13
FAQs	14
Troubleshooting	15
Tech Support	16
Limited Product Warranty Terms	16
Mission Statement	16
Copyright	16



Statement

Please read these instructions carefully before connecting, operating, or configuring this product. Please save this manual for future reference.

Safety Precaution

- To prevent damaging this product, avoid heavy pressure, strong vibration, or immersion during transportation, storage, and installation.
- The housing of this product is made of organic materials. Do not expose to any liquid, gas, or solids which may corrode the shell.
- Do not expose the product to rain or moisture.
- To prevent the risk of electric shock, do not open the case. Installation and maintenance should only be carried out by qualified technicians.
- Do not use the product beyond the specified temperature, humidity, or power supply specifications.
- This product does not contain parts that can be maintained or repaired by users. Damage caused by dismantling the product without authorization from BZBGear is not covered under the warranty policy.
- Installation and use of this product must strictly comply with local electrical safety standards.



Introduction

The BG-COMMANDER-G2 is a professional-grade IP/serial PTZ controller designed for seamless control of PTZ cameras in both networked and analog environments. It features dual control modes, supporting IP-based setups with unique IP and MAC addresses and traditional RS-422/RS-232 protocols for legacy systems. Its compatibility with industry-standard protocols such as VISCA over IP, ONVIF, NDI, VISCA, PELCO-P, and PELCO-D ensures it can integrate effortlessly into diverse camera ecosystems. The built-in 720x1280 HD touchscreen provides a crisp, intuitive interface for configuring and managing cameras, while the multi-axis, pressure-sensitive joystick offers precise pan, tilt, zoom, and focus adjustments, adapting seamlessly to user input.

Engineered for efficiency, the BG-COMMANDER-G2 includes seven programmable camera shortcut keys for rapid switching, browser-based configuration for remote management, and Power over Ethernet (PoE) support for simplified installation. The IP camera search function enables users to quickly and precisely add cameras. Additional features, such as a ship-type zoom switch, self-resetting knobs, and backlit silicone buttons, enhance usability in professional AV environments.

Features

- **Network Operation:** Equipped with a unique IP and MAC address for seamless network operation.
- **IP Protocol Support:** Compatible with VISCA over IP (UDP/TCP), ONVIF, and NDI for networked cameras.
- **IP Camera Search:** Supports NDI and ONVIF IP camera search for locating cameras on the network.
- **Analog Protocol Support:** Supports legacy systems with protocols like VISCA, PELCO-P, and PELCO-D.
- **HD LCD Touchscreen:** Integrated 720x1280 HD touchscreen delivers a vivid, user-friendly interface for effortless operation.
- **Precision Joystick Control:** A multi-axis, four-dimensional joystick offers precise pan, tilt, zoom, and focus control.
- **Adjustable Joystick Speed:** Joystick pressure allows for adjustable speed, enabling both fast and slow camera movements with ease.
- **Zoom Control:** Intuitive ship-type switch for smooth and powerful zoom adjustments.
- **Quick Camera Switching:** Features 7 programmable shortcut keys for efficient management of multiple cameras, enhancing productivity during meetings.
- **Browser-Based Configuration:** Simplified device setup with front-end parameter configuration through a web browser interface.
- **Standard PoE Power Supply:** Supports Power over Ethernet (PoE) for streamlined power and data management, reducing installation complexity.



Packing List

- 1x BG-COMMANDER-G2
- 1x DC12V-2A Adapter
- 1x Product Manual



Specifications

Technical Specifications	
Operating System	Linux
Supported Protocols	VISCA over IP (UDP/TCP), ONVIF, NDI, VISCA, PELCO-P, PELCO-D
Camera Search Protocols	ONVIF, NDI
Communication Interfaces	RS-422, RS-232, RJ45
Display	HD touchscreen (720x1280)
Cue Tone	Button sound prompt (On/Off)
Mechanical Specifications	
Key Physical Features	Self-resetting knob, stepless knob, backlit silicone buttons, 4D joystick
Power Consumption	≤5W
PoE Standards	PoE 802.3af/802.3at/802.3bt standards
Power Supply	DC12V-2A (Center Positive, Outer Negative)
Operating Temperature	14°F to 131°F / -10°C to 55°C
Operating Humidity	20% to 80% (non-condensing)
Storage Temperature	14°F to 140°F / -10°C to 60°C
Storage Humidity	0% to 90% (non-condensing)



Operation Controls and Functions

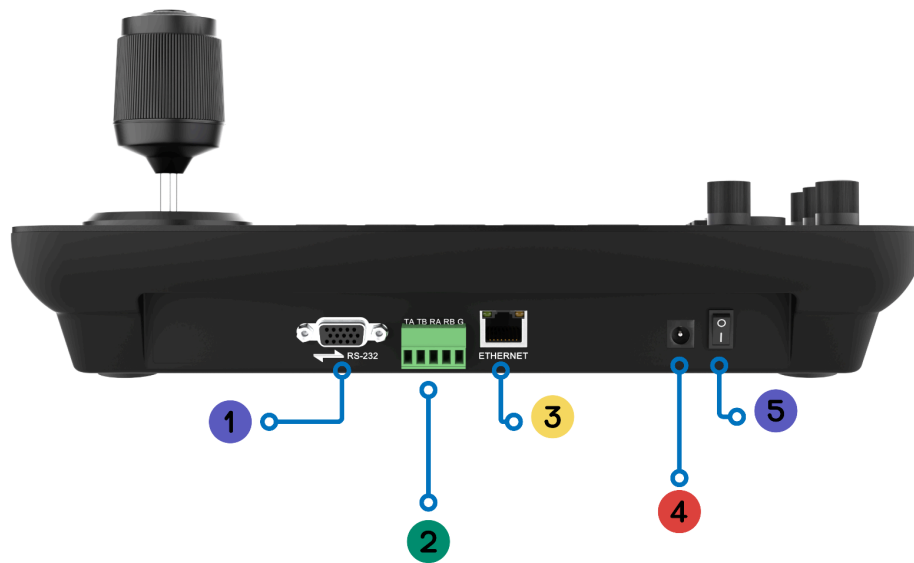

1. RS-232
2. RS-485/422
3. Ethernet Port
4. DC 12V2a Power Input
5. Power ON/OFF Switch



Button and Knob Functions

Buttons & Functions:

- **SETUP / MENU:** Short press → Home screen, Long press → Camera menu
 - **SET / CALL:** Set presets (long-press + numeric + ENTER), Recall presets (short-press + numeric + ENTER)
 - **MENU BACK / ENTER:** Navigate and confirm menu selections
 - **HOME:** Return to watch position
 - **BACKLIGHT ON/OFF:** Toggle backlight
 - **ONE PUSH TRIGGER / AF:** One-touch White Balance / Auto Focus
 - **AUTO WHITE BALANCE / EXPOSURE / FOCUS:** Automatic adjustment
 - **CAM ID / CAM 1-8:** Switch or select camera
 - **Numeric Keys (0-9):** Preset/camera ID input
 - **ESC / BACK / RECORD:** Back or start/stop recording (requires local storage)
 - **NEAR / FAR:** Manual focus
-

Knob Control Section

Knobs & Functions:

- **R GAIN / B GAIN:** Adjust red/blue color gain (press to toggle)
 - **ZOOM SPEED:** Zoom speed adjustment
 - **PT SPEED:** Pan-tilt speed adjustment
 - **IRIS:** Aperture / brightness control
 - **ZOOM:** Zoom in/out
-

Tips

- **Preset recall:** If camera doesn't move, it may already be at that position; move and try again.
- **Knobs:** Pressing certain knobs switches related settings (e.g., R ↔ B Gain).
- **Recording:** Only works with cameras that support local storage.



Connection Diagrams

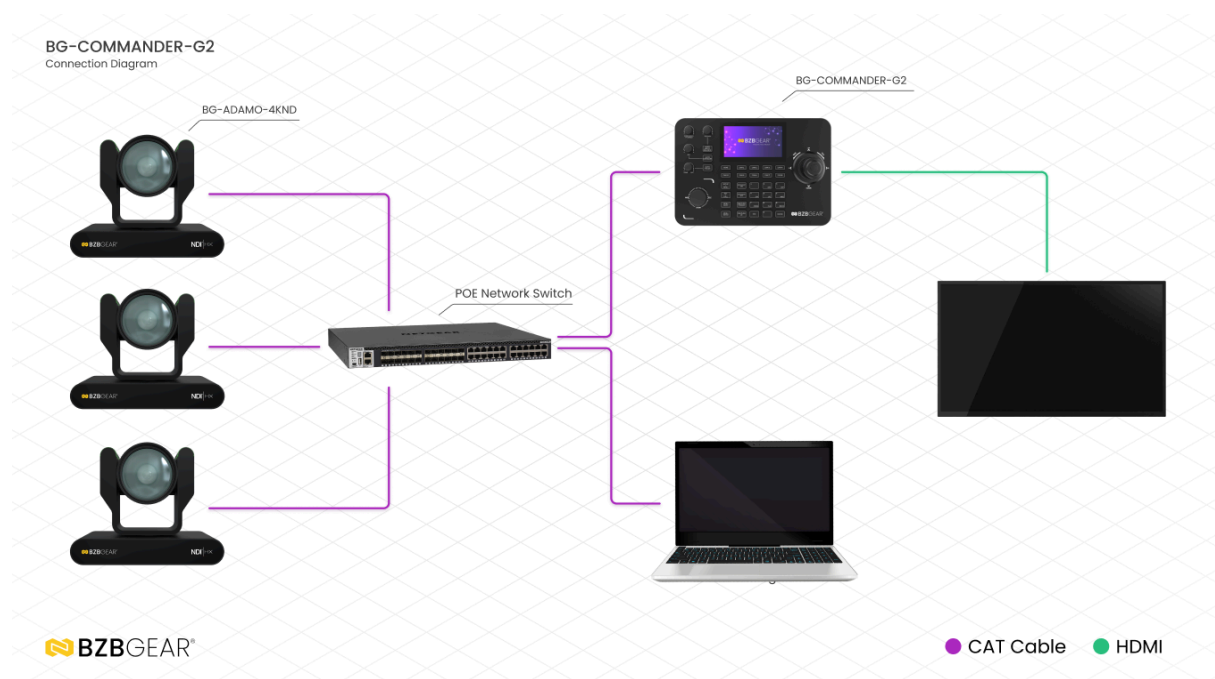

Serial Connection Guide

1. RS485 connection diagram

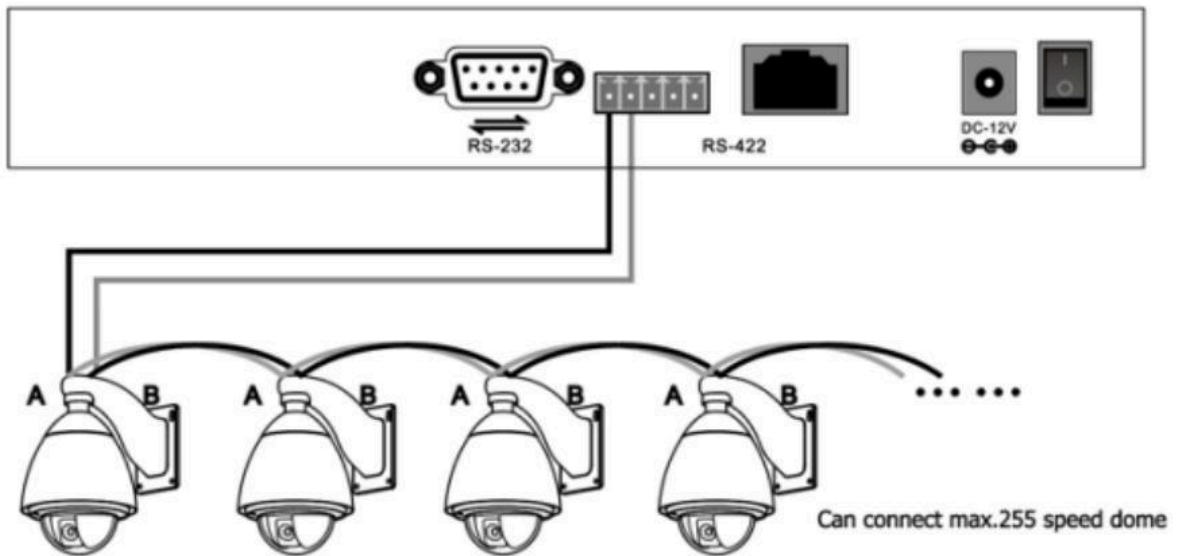

Control output:

The RS485+ of the camera is connected to the Ta of the controller, and the RS485- of the camera is connected to the Tb of the controller.



2. RS 422 connection diagram

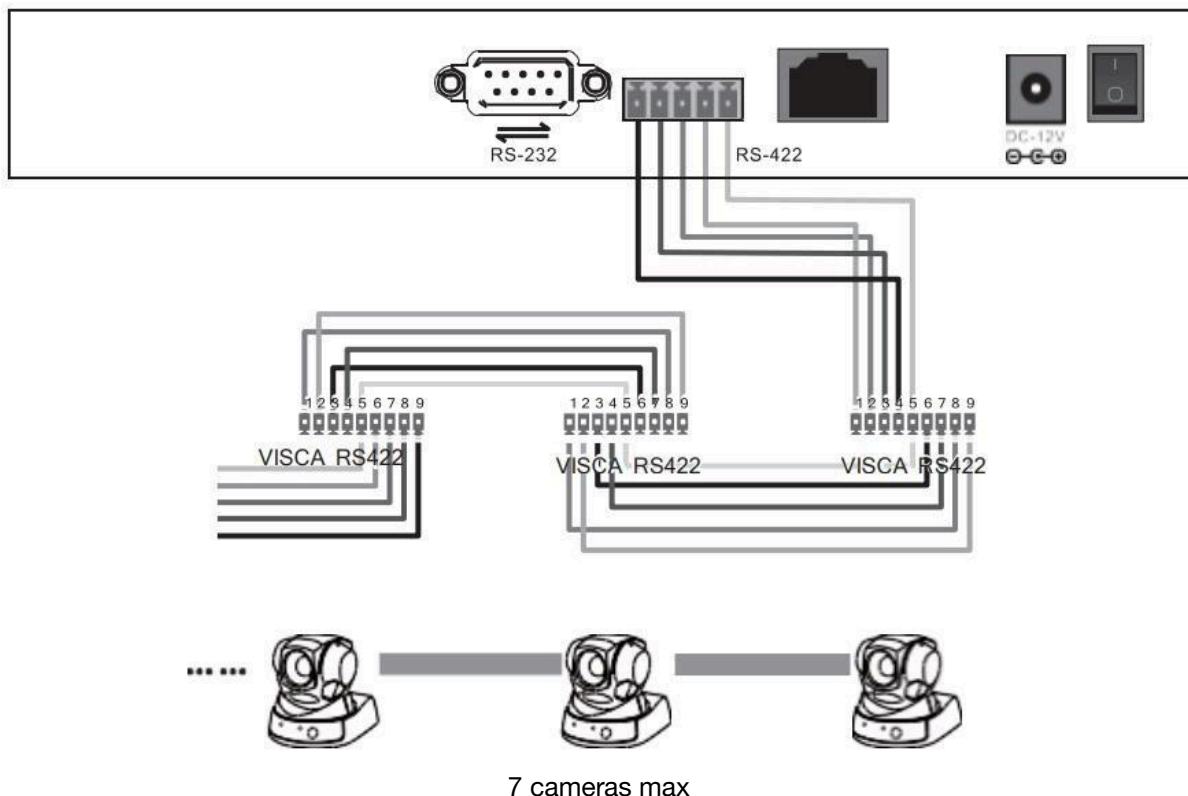

When using RS422 bus connection mode, the third pin (**Ra**) of the controller is connected to the **TXD IN-** of the camera, the fourth pin (**Rb**) of the controller is connected to the **TXD IN+** of the camera, the first pin (**Ta**) of the controller is connected to the **RXD IN-** of the camera, and the second pin (**Tb**) of the controller is connected to the **RXD IN+**

Controller	Camera
Ra	TXD IN-
Rb.....	TXD IN+
Ta.....	RXD IN-
Tb.....	RXD IN+

Using RS232 connection mode, the first pin (**RXD**) of the controller (10 Pin terminal) is connected to the camera input interface **TXD**, the second pin (**TXD**) of the controller is connected to the camera RXD, and the third pin of the controller is connected to the camera GND (you can also use the standard RS232 DB9 interface of the controller to connect the camera).

Controller	Camera
RXD	TXD
TXD	RXD
GND	GND



3. Connection between cameras

Using RS422 bus cascade connection mode, the output of camera 1 is connected to the input of camera 2, the output of camera 2 is connected to the input of camera 3, and so on. As below:

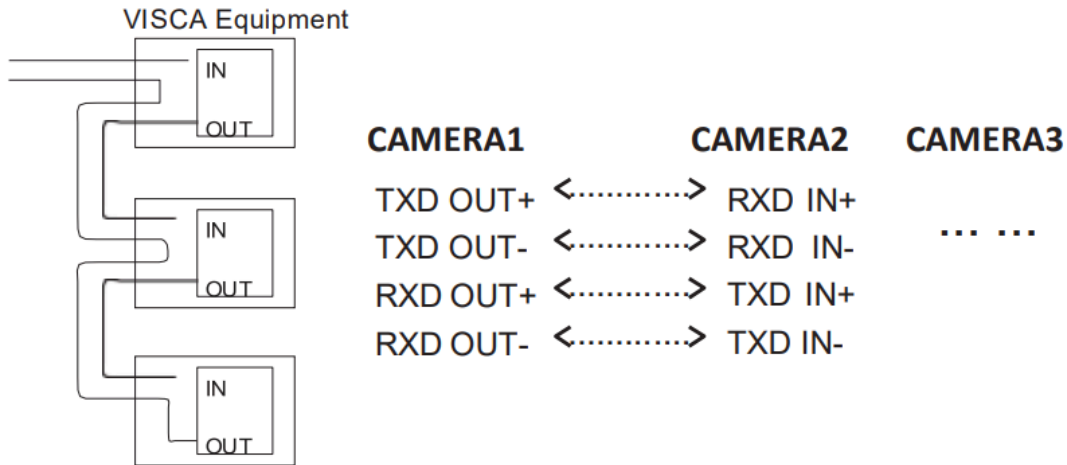

RS232 cascade connection

The output of camera 1 is connected to the input of camera 2, the output of camera 2 is connected to the input of camera 3, and so on.

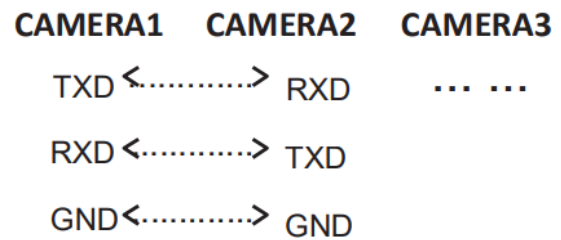



Web GUI

To access the Web GUI of the **BG-COMMANDER-G2**, enter the unit's IP address into the address bar of your web browser. This will open the login page. The default login credentials are:

- **Username:** admin
- **Password:** (leave blank)

Note: If you are unable to access the Web GUI, ensure that both the BG-COMMANDER-G2 and your computer are connected to the same network.

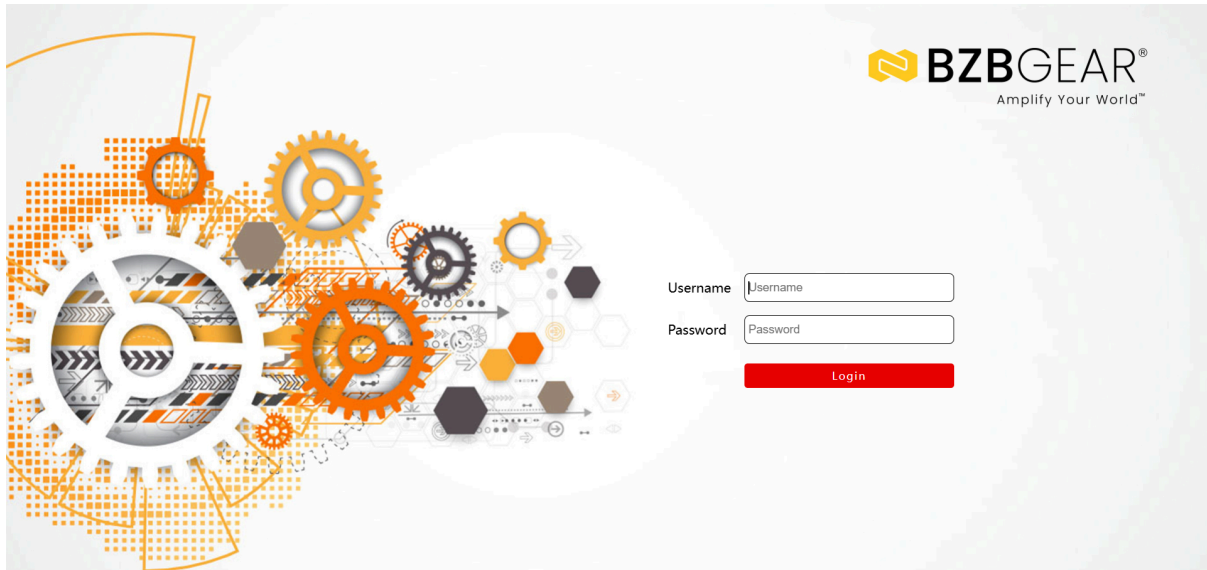



FAQs

(1) “Connection Failed” message appears on screen

- Ensure the device with the specified IP address is properly connected to the LAN.
- Verify that the network cable or Wi-Fi connection is stable.
- Confirm that the IP address is correct and not conflicting with another device.

(2) “Username/Password Error” message appears on screen

- Double-check the username and password entered for the device.
- Make sure there are no typing errors (case sensitivity matters).
- If the credentials were recently changed, update them in the system.

(3) Unable to add third-party devices via ONVIF protocol

- Confirm that the third-party camera supports ONVIF and has the feature enabled.
- Verify that the camera’s network settings (IP, port) match the configuration.
- Check if ONVIF access requires a specific username/password and use those credentials.



Troubleshooting

Problems	Causes	Solutions
No Power / All LED off	Power supply not connected, connected fully, or wrong power supply.	Check if the power supply is connected correctly and the output voltage value is within recommended specifications.
No sound or sound issues	The HDMI connection is faulty, the audio format is not supported by the displays, or the source player is set to another port for audio output	Check if the HDMI cables are connected correctly. Check if the audio format is supported by the display and that a user has not changed the supported audio format on the player's audio output. Ensure output settings from the HDMI source device as set correctly.
No picture or picture flickers	The HDMI cable may be faulty or the category cable quality is faulty.	Check if the HDMI and category cable connections are correct and undamaged. Change to another good working HDMI cable or category cable (CAT6 or better cable is recommended).



Tech Support

Have technical questions? We may have answered them already!

Please visit BZBGear's support page (bzbgear.com/support) for helpful information and tips regarding our products. Here you will find our Knowledge Base (bzbgear.com/knowledge-base) with detailed tutorials, quick start guides, and step-by-step troubleshooting instructions. Or explore our YouTube channel, BZB TV (youtube.com/c/BZBTVchannel), for help setting up, configuring, and other helpful how-to videos about our gear.

Need more in-depth support? Connect with one of our technical specialists directly:

Phone	Email	Live Chat
1.888.499.9906	support@bzbgear.com	bzbgear.com

Limited Product Warranty Terms

Pro Line: 5-year warranty from the date of purchase for AV/Broadcasting products bought on or after August 1, 2024.

Essential Line: 3-year warranty from the date of purchase for AV/Broadcasting products bought on or after August 1, 2024.

Cables: Lifetime Limited Product Warranty.

For complete warranty information, please visit bzbgear.com/warranty.

For questions, please call 1.888.499.9906 or email support@bzbgear.com.

Mission Statement

BZBGear is a breakthrough manufacturer of high-quality, innovative audiovisual equipment ranging from AVoIP, professional broadcasting, conferencing, home theater, to live streaming solutions. We pride ourselves on unparalleled customer support and services. Our team offers system design consultation, and highly reviewed technical support for all the products in our catalog. BZBGear delivers quality products designed with users in mind.

Copyright

All the contents in this manual and its copyright are owned by BZBGear. No one is allowed to imitate, copy, or translate this manual without BZBGear's permission. This manual contains no guarantee, standpoint expression or other implies in any form. Product specification and information in this manual is for reference only and subject to change without notice.

All rights reserved. No reproducing is allowed without acknowledgement.